

RESIDENTIAL  
RESIDENCIAL  
/21



# ÍNDICE /

INDEX · TABLE · ИНДЕКС

<b>SIMBOLOGÍA</b> ICONOGRAPHY	02	<b>ESQUEMAS DE COLOCACIÓN MF</b> MULTIFORMAT LAYING PATTERNS	264 - 265
<b>ÍNDICE SERIES</b> SERIES INDEX	03	<b>SOLUCIONES TÉCNICAS</b> TECHNICAL SOLUTIONS	266 - 277
<b>SOBRE NOSOTROS</b> ABOUT US	04 - 11	<b>RECOMENDACIONES COLOCACIÓN</b> TILING RECOMMENDATIONS	278 - 281
<b>SERIES MARBLE</b> MARBLE SERIES	12 - 105	<b>PROCESO EXTRUSIÓN</b> EXTRUSION PROCESS	282 - 283
<b>SERIES WOOD</b> WOOD SERIES	106 - 137	<b>CARACTERÍSTICAS TÉCNICAS</b> TECHNICAL DATA	284 - 293
<b>SERIES URBAN</b> URBAN SERIES	138 - 169	<b>LISTA DE EMBALAJE</b> PACKING LIST	294 - 303
<b>SERIES STONE</b> STONE SERIES	170 - 241		
<b>SERIES EARTH</b> EARTH SERIES	242 - 257		
<b>SERIES METAL</b> METAL SERIES	258 - 263		

# SIMBOLOGÍA /

ICONOGRAPHY · ICONOGRAPHIE · УСЛОВНЫЕ ОБОЗНАЧЕНИЯ

 **RESISTENCIA AL DESLIZAMIENTO (rampa pie calzado) · ANTI-SLIP RESISTANCE (ramp)**  
RÉSISTANCE AU GLISSEMENT (pied chaussé) · СОПРОТИВЛЕНИЕ СКОЛЬЖЕНИЮ (если ходит обутым)

 **RESISTENCIA AL DESLIZAMIENTO (pie descalzo) · ANTI-SLIP RESISTANCE (barefoot)**  
RÉSISTANCE AU GLISSEMENT (pied nu) · СОПРОТИВЛЕНИЕ СКОЛЬЖЕНИЮ (босые ноги)

 **RESISTENCIA AL DESLIZAMIENTO (C.T.E.) · ANTI-SLIP RESISTANCE (C.T.E)**  
RÉSISTANCE AU GLISSEMENT (C.T.E.) · СОПРОТИВЛЕНИЕ СКОЛЬЖЕНИЮ (C.T.E.)

 **RESISTENCIA A LA FLEXIÓN · MODULUS OF RUPTUR**  
RÉSISTANCE À LA FLEXION · СОПРОТИВЛЕНИЕ НА ИЗГИБ

 **RESISTENCIA AL CUARTEO · CRACKING RESISTANCE**  
RÉSISTANCE AU TRESSAILLAGE · УСТОЙЧИВОСТЬ К РАСТРЕСКИВАНИЮ

 **ABSORCIÓN DE AGUA · WATER ABSORPTION**  
ABSORPTION D'EAU · ВОДОПОГЛОЩЕНИЕ

 **RESISTENCIA A LOS AGENTES QUÍMICOS · CHEMICAL RESISTANCE**  
RÉSISTANCE AUX PRODUITS CHIMIQUES · СТОЙКОСТЬ К ВОЗДЕЙСТВИЮ ХИМИКАТОВ

 **RESISTENCIA A LA HELADA · FROST RESISTANCE**  
RÉSISTANCE AU GEL · МОРОЗОСТОЙКОСТЬ

 **IMPRESIÓN DIGITAL · DIGITAL PRINTING**  
DIGITAL IMPRESSION · ЦИФРОВАЯ ПЕЧАТЬ

 **DORSO ESTRIADO EN COLA DE MILANO · DOVE TAIL PROFILE**  
FAÇONNAGE EN QUEUE D'ARONDE AU DOS DES CARREAUX · Ласточкин хвост» на задней стороне плитк

 **LIGERA VARIACIÓN EN TONALIDAD Y GRÁFICAS · SLIGHT VARIATION IN TONE AND GRAPHICS**  
LÉGÈRE VARIATION DE LA TEINTE ET DES GRAPHIQUES · НЕБОЛЬШОЕ РАЗЛИЧИЕ В ОТТЕНКАХ И РИСУНКАХ

 **MODERADA VARIACIÓN EN TONALIDAD Y GRÁFICAS · MODERATE VARIATION IN TONE AND GRAPHICS**  
VARIATION MODÉRÉE DE LA TEINTE ET DES GRAPHIQUES · СРЕДНЕЕ РАЗЛИЧИЕ В ОТТЕНКАХ И РИСУНКАХ

 **CONTRASTE DE TONALIDAD Y VARIEDAD DE GRÁFICAS · CONTRAST IN TONE AND VARIETY OF GRAPHICS**  
CONTRASTE DE TEINTE ET VARIÉTÉ DE GRAPHIQUES · КОНТРАСТНЫЕ ОТТЕНКИ И РАЗНООБРАЗИЕ РИСУНКОВ

 **RELIEVE SUPERFICIAL · SUPERFICIAL RELIEF**  
RELIEF SUPERFICIEL · РЕЛЬЕФНАЯ ПОВЕРХНОСТЬ

 **RECTIFICADO · RECTIFIED**  
CARRELAGE RECTIFIÉ · РЕКТИФИЦИРОВАННАЯ ПЛИТКА

 **DISEÑO 3D · 3D DESIGN**  
DESIGN 3D · ДИЗАЙН 3D

 **NO REJUNTAR · NO PEGAR · DO NOT GROUT · DO NOT GLUE**  
NE PAS JOINTOYER · NE PAS COLLER · НЕ ЗАТИРАТЬ · НЕ КЛЕИТЬ

# ÍNDICE SERIES /

SERIES INDEX · TABLE DES SÉRIES · СОДЕРЖАНИЕ

## 1. MARBLE

IMPERIAL	12 - 45
VENATTO	46 - 59
NUBIA	60 - 69
OROBICO	70 - 83
MARBLES	84 - 95
MARKINA	96 - 105

## 2. WOOD

YOHO	106 - 125
KIOTO	126 - 131
NATURA	132 - 137

## 3. URBAN

ÓPERA	138 - 163
MEDITERRÁNEO	164 - 169

## 4. STONE

MILÁN	170 - 189
ALBAROC	190 - 203
LITOS	204 - 217
ROCA	218 - 223
MANHATTAN	224 - 231
PETRA	232 - 237
VEGA	238 - 241

## 5. EARTH

LUCCA	242 - 251
ALHAMAR	252 - 257

## 6. METAL

METÁLICA	258 - 263
----------	-----------

## EMPRESA /

COMPANY · ENTERPRISE · КОМПАНИЯ

A principios de los años 70, EXAGRES se introduce en el mercado del extruido. Desde su fundación, la empresa desempeña un papel fundamental de liderazgo en la investigación de materias primas y procesos productivos, poniendo al alcance de grandes profesionales, soluciones en la aplicación cerámica, desarrollando piezas especiales como peldaños, esquinas, ángulos, vierteaguas, bordes de piscinas, etc. que posicionan a Exagres, como líder en la fabricación en Europa. Pero esta Innovación y Desarrollo se traslada al mercado en voz de un equipo con talento, cercano y a la escucha de cada una de las necesidades de clientes y profesionales. En la actualidad, Exagres se afianza, con la seguridad de 40 años de innovación tecnológica, conocimiento y entendimiento de múltiples necesidades para lograr productos de calidad y crear valor añadido a través una cultura de gestión integral y mejora continua, fundamentada en la calidad del servicio y producto, la protección ambiental, la seguridad y salud de las personas que forman parte de nuestra empresa.

At the beginning of the 70s, EXAGRES joined the market of extruded products. Since it was founded, the company has played a fundamental role in the leadership researching raw materials and production processes, providing solutions for ceramic applications in the hands of great professionals, developing special pieces such as steps, corners, angles, gutters, pool edging, etc. these facts position Exagres as a leading manufacturer in Europe. Innovation and development are transferred to the market through the voice of a talented, friendly team that is capable to listen to each of the needs of their customers and professionals. Currently, Exagres is strengthened of 40 years of technological innovation, knowledge and understanding of multiple needs in order to achieve quality products, creating added value through a culture of integral management and continuous improvement, based on the quality of the service and product, environmental protection and the health and safety of the people who form part of our company.

Au début des années 70, EXAGRES pénètre dans le marché de l'extrusion. Depuis sa fondation, l'entreprise remplit un rôle essentiel de leadership dans la recherche de matières premières et processus de production, mettant à la portée des grands professionnels des solutions dans l'application céramique, en développant des pièces spéciales telles que des marches, des coins, des angles, des revingots, des rebords de piscines, etc., qui placent Exagres à la tête de la fabrication en Europe. Cependant, cette innovation et ce développement sont transférés au marché au nom d'une équipe talentueuse, proche et à l'écoute de chacune des nécessités de clients et professionnels. À présent, Exagres se consolide, avec la sécurité de 40 ans d'innovation technologique, connaissance et compréhension de nécessités multiples pour obtenir des produits de qualité et créer de la valeur ajoutée à travers une culture de gestion intégrale et amélioration continue, qui se fonde sur la qualité du service et du produit, la protection environnementale, la sécurité et la santé des personnes qui font partie de notre entreprise.

Компания EXAGRES начала свою деятельность на рынке экструдированной керамики в начале 70-х годов. С момента своего основания она стала одним из лидеров в научных исследованиях в области первичного сырья и производственных процессов, занимая ведущую позицию среди производителей в Европе. Exagres предлагает профессионалам различные решения в области применения керамики, в том числе специальные элементы: ступени, внутренние и внешние углы, водостоки, бортики бассейнов и др. Инновации и опытные разработки осуществляет команда талантливых сотрудников, которые внимательно относятся к мнению клиентов и профессионалов, стремясь удовлетворять все их потребности. Exagres имеет 40-летний опыт в области технологических инноваций. Ее персонал располагает обширными знаниями, в том числе о различных потребностях и запросах, что позволяет создавать высококачественные продукты с дополнительной ценностью. В компании существует особая культура комплексного менеджмента и постоянного совершенствования, основанная на качестве услуг и продукции, защите окружающей среды, а также на обеспечении безопасности и охране здоровья трудящихся.



## PRODUCTO /

PRODUCT · PRODUIT · ПРОДУКТЫ

Las exigencias en arquitectura varían con el paso de los años, por ello, EXAGRES propone soluciones y superficies que garantizan altos niveles de prestaciones técnicas y estéticas a la vez que respetan las necesidades de la construcción. El producto de Exagres, con su particular sistema de fabricación, la extrusión, es capaz de generar diferentes formatos y tipos de piezas especiales, todo ello, facilitando su colocación al profesional.

Las series de Exagres garantizan funcionalidad y un alto contenido estético en cada tipo de proyecto. Desde la arquitectura urbana, el uso industrial e incluso en la realización de todo tipo de diseños de carácter residencial en interiores, exteriores y recubrimiento de piscinas.

The requirements of architecture vary over time, therefore, EXAGRES proposes solutions and surfaces that guarantee high levels of technical and aesthetic qualities while also respecting the needs of the construction.

The Exagres product, with its unique manufacturing system, extrusion, is capable of generating different formats and types of special pieces, thus facilitating placement by a professional.

The Exagres series guarantee functionality and a high aesthetic content in each type of project. From urban architecture, industrial use and even use in all types of designs of a residential nature for interiors, exteriors and swimming pool cladding.

Les exigences en architecture varient au fil des années. De ce fait, EXAGRES propose des solutions et des surfaces qui garantissent de hauts niveaux de prestations techniques et esthétiques en respectant en même temps les nécessités de la construction.

Le produit d'Exagres, avec son système particulier de fabrication, l'extrusion, est capable de générer plusieurs formats et types de pièces spéciales, le tout en facilitant sa pose au professionnel.

Les séries d'Exagres garantissent la fonctionnalité et une haute teneur esthétique dans chaque type de projet. Depuis l'architecture urbaine, l'utilisation industrielle et même dans la réalisation de toute sorte de conceptions à caractère résidentiel en intérieur, extérieur et recouvrement de piscines.

С течением времени требования, предъявляемые к различным материалам в архитектуре, варьируются. Поэтому EXAGRES предлагает решения, которые не только гарантируют высокий уровень технических и эстетических характеристик, но также обеспечивают соответствие потребностям строительства.

Продукты компании Exagres производятся с помощью особой технологии-экструзии, которая позволяет создавать различные форматы и элементы разных форм, что облегчает процесс укладки.

Серии Exagres гарантируют функциональность и прекрасные эстетические характеристики для каждого типа проекта, включая городскую архитектуру, промышленное использование, интерьеры и наружные пространства всевозможных жилых домов, а также покрытия для бассейнов.



## SISTEMA INTEGRADO DE GESTIÓN / INTEGRATED MANAGEMENT SYSTEM · КОМПЛЕКСНАЯ СИСТЕМА УПРАВЛЕНИЯ

En Exagres somos responsables con el medio ambiente. Además utilizamos las herramientas de gestión adecuadas para garantizar la calidad, la protección del medio ambiente, la seguridad y la salud.

At Exagres we are environmentally responsible. For this reason we use the appropriate management tools to guarantee quality, environment, safety and health.

Chez Exagres nous sommes responsables de l'environnement. Pour cette raison, nous utilisons les outils de gestion adaptés afin de garantir la qualité, l'environnement, la sécurité et la santé.

В Exagres мы ответственно относимся к охране окружающей среды. Именно поэтому мы используем инструменты управления, обеспечивающие высокое качество продукции, защиту окружающей среды, безопасность и охрану здоровья.



**ISO 9001: 2015**  
Sistemas de gestión de la calidad.  
Quality management systems.  
Systèmes de gestion de la qualité.  
Системы менеджмента качества.



**ISO 14001: 2015**  
Sistemas de gestión medioambiental.  
Environmental management systems.  
Systèmes de gestion environnementale.  
Системы экологического менеджмента.



**ISO 45001: 2018**  
Sistemas de gestión de la seguridad y salud en el trabajo.  
Occupational Health and Safety management systems.  
Systèmes de gestion de la santé et de la sécurité au travail.  
Системы управления охраной труда и промышленной безопасностью.



**AAI**  
Certificado Autorización Ambiental Integrada.  
Integrated Environmental Authorisation Certificate.  
Certificat d'autorisation environnementale intégrée.  
Интегрированное свидетельство об экологическом авторизации.



Sello de reducción de huella de carbono.  
Carbon footprint reduction label.  
Label de réduction de l'empreinte carbone.  
маркировка сокращения выбросов углекислого газа



Declaración ambiental de producto.  
Environmental product declaration.  
Déclaration environnementale de produit.  
Экологическая декларация продукции.

## LIBRERÍA BIM /

BIM LIBRARY · LIBRAIRIE BIM · КНИЖНЫЙ

BIM

Exagres se suma al sistema de trabajo en BIM, distribuyendo a los agentes intervinientes de la edificación sus productos cerámicos. Los modelos BIM contienen los datos necesarios para que los prescriptores puedan elegir el material siguiendo los criterios pertinentes para cada uso. Además, el arquitecto podrá generar imágenes de alta calidad, para poder mostrar a sus clientes el ambiente con mayor fidelidad.

Exagres joins the BIM work system, distributing its ceramic products to the agents involved in building. BIM models contain the required data in order to construction specifiers can choose the right material according to the relevant criteria for each use. Furthermore, the architect will be able to generate high quality images to show the environment to his customers with greater accuracy.

Exagres s'associe au système de travail BIM, en distribuant aux agents intervenants de la construction leur produits en céramique. Les modèles BIM contiennent les données nécessaires pour que les prescripteurs puissent choisir le matériel en suivant les critères pertinentes pour chaque usage. En plus, l'architecte pourra générer des images d'haute qualité, pour pouvoir montrer aux clients l'ambiance avec plus de fidélité.

Exagres присоединяется к современной системе информационного моделирования BIM, распределяя среди участвующих лиц достижения в керамической деятельности. Модели BIM содержат в себе все необходимые данные, позволяющие выбирать материал в соответствии с особенностями каждого использования. Кроме того, архитектор сможет генерировать высококачественные изображения и демонстрировать клиентам пространства с большей точностью.

## CERTIFICACIONES /

CERTIFICATIONS · CERTIFICATIONS · СЕРТИФИКАТЫ



La Confederación Española de la Pequeña y Mediana Empresa (CEPYME) ha seleccionado a Exagres como una de las 500 empresas que lideran el crecimiento empresarial, tanto por sus resultados obtenidos en los últimos años, como por su capacidad para generar actividad y empleo, su potencial de innovación y su proyección internacional.

The Spanish Confederation of Small and Medium-Size Enterprises (CEPYME) has chosen Exagres as one of the 500 companies that lead business growth due to its results obtained in recent years, the ability to generate activity and employment, its potential of innovation and international projection.

La Confederation Espagnole de la petite et moyenne entreprise (CEPYME) a sélectionné a Exagres comme l'une de 500 entreprises qui mènent la croissance entrepreneuriale tant par ses excellents résultats obtenus dans les dernières années, que pour sa capacité pour générer activité et emploi, son potentiel d'innovation et sa projection internationale.

Согласно исследованиям Испанской Конфедерации Малых и Средних Предприятий (CEPYME), Exagres вошла в рейтинг 500 быстрорастущих керамических производителей, как за результатами предыдущего года, так и способностью генерировать занятость, потенциал инноваций и международную деятельность.

## PREMIOS /

AWARDS · DISTINCTIONS · НАГРАДЫ



DIPUTACIÓ  
D  
CASTELLÓ

En la edición de la Feria Cevisama 2019, la nueva línea de suelo técnico cerámico Exadeck de Exagres fue galardonado con el premio "SOM CERÀMICA", otorgado por la Diputación de Castellón en reconocimiento a la innovación del producto cerámico para su uso en aplicaciones urbanas.

In Cevisama Fair 2019, the new line of ceramic technical floor, Exadeck by Exagres, was awarded the SOM CERÀMICA prize by the Council of Castellón in recognition of the innovation of the ceramic product for use in urban applications.

Dans l'édition de la foire Cevisama 2019, la nouvelle ligne du sol technique céramique Exadeck d'Exagres a reçu le prix "SOM CERAMICA" décerné par la Diputación de Castellón en récompense à l'innovation du produit céramique pour usage dans des applications urbaines.

На международной выставке Cevisama Fair 2019, Мария города Кастельон удостоила новую линию технического керамического пола Exadeck от Exagres, награды «SOM CERÀMICA», за достижения в области развития инновационного керамического продукта и его использования в городских условиях.



MARBLE



# IMPERIAL

CHROMATIC VARIETY IN MARBLE  
IN&OUTDOOR  
LARGE FORMATS  
STAIRS  
SWIMMINGPOOLS

COLORS:	SIZES (cm):	SIZES (inches):
ARIAN	120x120 cm	47.2"x47.2"
CENIZA	60x120 cm	23.7"x47.2"
MOCA	60x60 cm	23.7"x23.7"
SIENA	14,5x120 cm	5.7"x47.2"
	33x66,5 cm	13.0"x26.2"



IMPERIAL CENIZA 60x120 CM [C-3] / 60x60 CM [C-1] - BORDE DESBORDANTE 28x66,5 CM [C-3] - ÁNGULO DESBORDANTE 21x31 CM [C-3]  
REJILLA 24,5x24,5 CM [C-3] - ÁNGULO REJILLA 24,5x33 CM [C-3]

# IMPERIAL / ARIAN

GRES EXTRUIDO · EXTRUDED KLINKER · GRÈS EXTRUDÉ · ЭКСТРУДИРОВАННЫЙ КЕРАМОГРАНИТ  
GRES PORCELÁNICO · PORCELAIN STONEWARE · GRÈS PORCELAINÉ · КЕРАМОГРАНИТ



R9 C-1 Alb <1,5% V2  
R11 C-3 CLASE C Bla <0,5%

FORMATOS · SIZES · FORMATS · ФОРМАТЫ

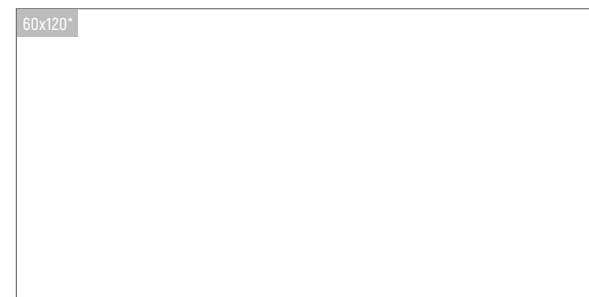
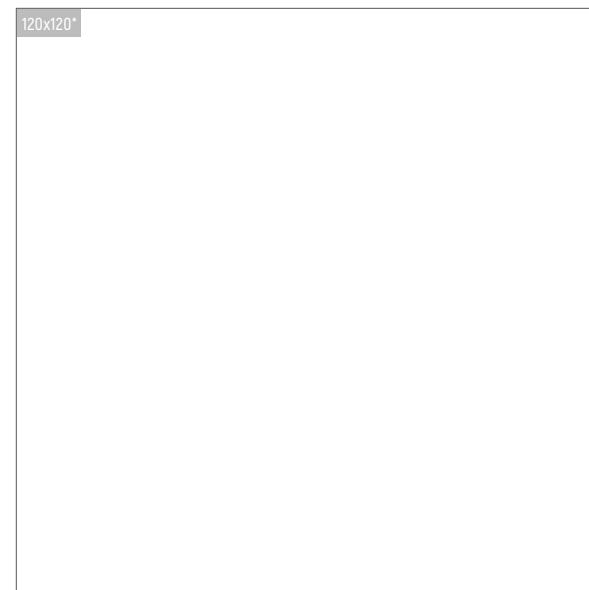

**120x120\***  
120 x 120 cm -  
47.2"x 47.2"

10 mm  
rectificado, rectified  
C-1/C-3

**60x120\***  
60 x 120 cm -  
23.7"x 47.2"

10 mm  
rectificado, rectified  
C-1/C-3

**14,5x120\***  
14,5 x 120 cm -  
5.7"x 47.2"

10 mm  
rectificado, rectified  
C-1

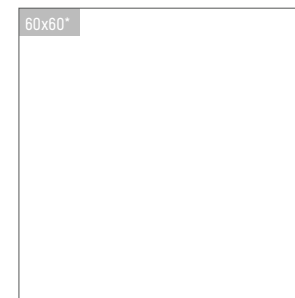

**60x60\***  
60 x 60 cm -  
23.7"x 23.7"

10,3 mm  
rectificado, rectified  
C-1

**33x66,5**  
33 x 66,5 cm -  
13.0"x 26.2"

10 mm  
C-1/C-3

PIEZAS ESPECIALES · SPECIAL PIECES · PIÈCES SPÉCIALES · СПЕЦИАЛЬНЫЕ ЭЛЕМЕНТЫ



**PELDAÑO RECTO 120**  
33 x 120 x 3 cm - 13.0"x 47.2"x 1.2"

12 mm  
rectificado, rectified  
C-1/C-3

**REMATE PELDAÑO RECTO**  
3 x 33 cm - 1.2"x 13.0"



**ZANQUÍN RECTO IZDA/DCHA**  
42,3 x 17,5 cm - 16.7"x 6.9"

7,5 mm



**PELDAÑO ML 120**  
33 x 120 x 4 cm - 13.0"x 47.2"x 1.6"

13 mm  
rectificado, rectified  
C-1

**REMATE ML**  
4 x 33 cm - 1.6"x 13.0"



**ZANQUÍN ML IZDA/DCHA**  
39,5 x 17,5 cm - 15.6"x 6.9"

7,5 mm



**RODAPIÉ**  
9 x 60 cm - 3.6"x 23.6"

11 mm

PIEZAS ESPECIALES · SPECIAL PIECES · PIÈCES SPÉCIALES · СПЕЦИАЛЬНЫЕ ЭЛЕМЕНТЫ



**BORDE SKIMMER**  
45 x 75 x 3 cm - 17.7" x 29.5" x 1.2"  
 rectificado, rectified  
 C-3

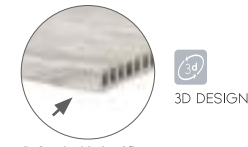

D. Continuidad gráfica, parte trasera.  
Graphic continuous, backside.



**BORDE DESBORDANTE**  
28 x 66,5 cm - 11.0" x 26.2"  
 rectificado, rectified  
 C-3



**ÁNGULO DESBORDANTE**  
31 x 31 cm - 12.2" x 12.2"  
 rectificado, rectified  
 C-3



**REJILLA**  
24,5 x 24,5 cm - 9.6" x 9.6"  
 rectificado, rectified  
 C-3



**ÁNGULO REJILLA DERECHA\***  
24,5 x 33 cm - 9.6" x 13.0"  
 rectificado, rectified  
 C-3



**ÁNGULO REJILLA IZQUIERDA\***  
24,5 x 33 cm - 9.6" x 13.0"  
 rectificado, rectified  
 C-3

\*set de 2 piezas [izda./dcha.] \*two pieces set [left/right]



**MEDIA CAÑA**  
33 x 4 cm - 13.0" x 1.6"  
r-3 cm



**UÑA**  
4 x 4 cm  
1.6" x 1.6"



**ÁNGULO EXTERIOR ARISTA**  
5 x 5 cm  
2" x 2"



**ARISTA**  
33 x 3 cm - 13.0" x 1.2"  
r-3 cm



**UÑA ARISTA**  
3 x 3 cm  
1.2" x 1.2"



**ÁNGULO INTERIOR ARISTA**  
5 x 5 cm  
2" x 2"

IMPERIAL ARIAN 60x120 CM (C-3) - PELDAÑO RECTO 120 33x120x3 CM (C-1/C-3) - TABICA IMPERIAL ARIAN 14,5x120 CM - BORDE SKIMMER 45x75x3 CM (C-3)





# IMPERIAL / ARIAN



INDOOR: IMPERIAL ARIAN 120x120 CM [C-1] / 60x120 CM [C-1] - PELDAÑO RECTO 120 33x120x3 CM [C-1] - TABICA IMPERIAL ARIAN 14,5x120 CM - OROBICO TAUPE 60x120 CM [C-1]

OUTDOOR: IMPERIAL ARIAN 120x120 CM [C-3]





# IMPERIAL / ARIAN

INDOOR: IMPERIAL ARIAN 60x120 CM [C-1] - PELDAÑO ML 120 33x120x4 CM [C-1] - TABICA IMPERIAL ARIAN 14,5x120 CM





# IMPERIAL / CENIZA

GRES EXTRUIDO · EXTRUDED KLINKER · GRÈS EXTRUDÉ · ЭКСТРУДИРОВАННЫЙ КЕРАМОГРАНИТ  
GRES PORCELÁNICO · PORCELAIN STONWARE · GRÈS PORCELAINÉ · КЕРАМОГРАНИТ



R9 C-1 Alb <1,5% V2  
R11 C-3 CLASE C Bla <0,5%

FORMATOS · SIZES · FORMATS · ФОРМАТЫ

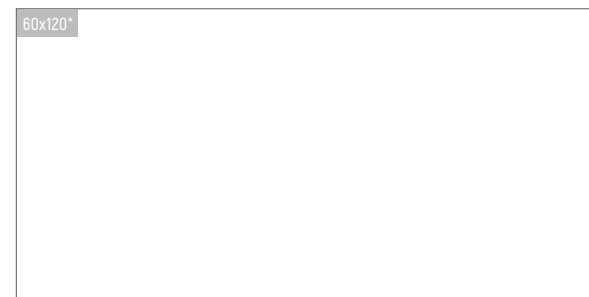
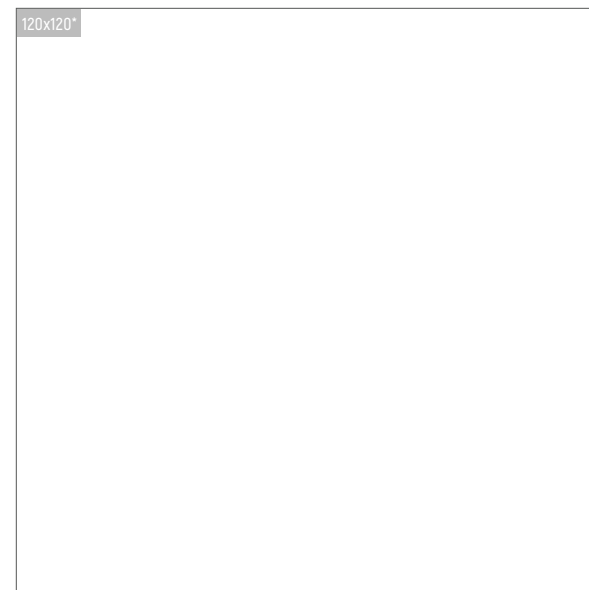

**120x120\***  
120 x 120 cm -  
47.2"x 47.2"

± 10 mm  
rectificado, rectified  
C-1/C-3

**60x120\***  
60 x 120 cm -  
23.7"x 47.2"

± 10 mm  
rectificado, rectified  
C-1/C-3

**14,5x120\***  
14,5 x 120 cm -  
5.7"x 47.2"

± 10 mm  
rectificado, rectified  
C-1

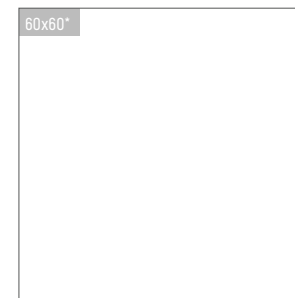

**60x60\***  
60 x 60 cm -  
23.7"x 23.7"

± 10,3 mm  
rectificado, rectified  
C-1

**33x66,5**  
33 x 66,5 cm -  
13.0"x 26.2"

± 10 mm  
C-1/C-3

PIEZAS ESPECIALES · SPECIAL PIECES · PIÈCES SPÉCIALES · СПЕЦИАЛЬНЫЕ ЭЛЕМЕНТЫ



**PELDAÑO RECTO 120**  
33 x 120 x 3 cm - 13.0"x 47.2"x 1.2"

± 12 mm  
rectificado, rectified  
C-1/C-3



**REMATE PELDAÑO RECTO**  
3 x 33 cm - 1.2"x 13.0"



**ZANQUÍN RECTO IZDA/DCHA**  
42,3 x 17,5 cm - 16.7"x 6.9"

± 7,5 mm



**PELDAÑO ML 120**  
33 x 120 x 4 cm - 13.0"x 47.2"x 1.6"

± 13 mm  
rectificado, rectified  
C-1



**REMATE ML**  
4 x 33 cm - 1.6"x 13.0"



**ZANQUÍN ML IZDA/DCHA**  
39,5 x 17,5 cm - 15.6"x 6.9"

± 7,5 mm



**RODAPIÉ**  
9 x 60 cm - 3.6"x 23.6"

± 11 mm

PIEZAS ESPECIALES · SPECIAL PIECES · PIÈCES SPÉCIALES · СПЕЦИАЛЬНЫЕ ЭЛЕМЕНТЫ



D. Continuidad gráfica, parte trasera.  
Graphic continuous, backside.

**BORDE SKIMMER**  
45 x 75 x 3 cm - 17.7" x 29.5" x 1.2"

rectificado, rectified  
C-3



**BORDE DESBORDANTE**  
28 x 66,5 cm - 11.0" x 26.2"

rectificado, rectified  
C-3



**ÁNGULO DESBORDANTE**  
31 x 31 cm - 12.2" x 12.2"

rectificado, rectified  
C-3



**REJILLA**  
24,5 x 24,5 cm - 9.6" x 9.6"

rectificado, rectified  
C-3



**ÁNGULO REJILLA DERECHA\***  
24,5 x 33 cm - 9.6" x 13.0"

rectificado, rectified  
C-3



**ÁNGULO REJILLA IZQUIERDA\***  
24,5 x 33 cm - 9.6" x 13.0"

rectificado, rectified  
C-3

\*set de 2 piezas [izda./dcha.] \*two pieces set [left/right]



**MEDIA CAÑA**  
33 x 4 cm - 13.0" x 1.6"  
r-3 cm



**UÑA**  
4 x 4 cm  
1.6" x 1.6"



**ÁNGULO EXTERIOR ARISTA**  
5 x 5 cm  
2" x 2"



**ARISTA**  
33 x 3 cm - 13.0" x 1.2"  
r-3 cm



**UÑA ARISTA**  
3 x 3 cm  
1.2" x 1.2"



**ÁNGULO INTERIOR ARISTA**  
5 x 5 cm  
2" x 2"

IMPERIAL CENIZA 60x120 CM [C-3] / 33x66,5 CM [C-3] - BORDE SKIMMER 45x75x3 CM [C-3] - PELDAÑO RECTO 120 33x120x3 CM [C-3] - TABICA IMPERIAL CENIZA 14,5x120 CM YOHO NATURAL 24,5x150 CM [C-3] - PELDAÑO RECTO 120 YOHO NATURAL 33x120x3 CM [C-3]





# IMPERIAL / CENIZA



OUTDOOR: IMPERIAL CENIZA 120x120 CM [C-3] - BORDE DESBORDANTE 28x66,5 CM [C-3] - REJILLA 24,5x24,5 CM [C-3]

INDOOR: IMPERIAL CENIZA 60x60 CM [C-1] - ÓPERA IVORY 60x120 CM [C-1]





# IMPERIAL / CENIZA

IMPERIAL CENIZA 60x120 CM (C-3) / 33x66,5 CM (C-3) - BORDE SKIMMER 45x75x3 CM (C-3) - PELDAÑO RECTO 120 33x120x3 CM (C-3) - TABICA IMPERIAL CENIZA 14,5x120 CM

YOHO NATURAL 24,5x150 CM (C-3) - PELDAÑO RECTO 120 YOHO NATURAL 33x120x3 CM (C-3)

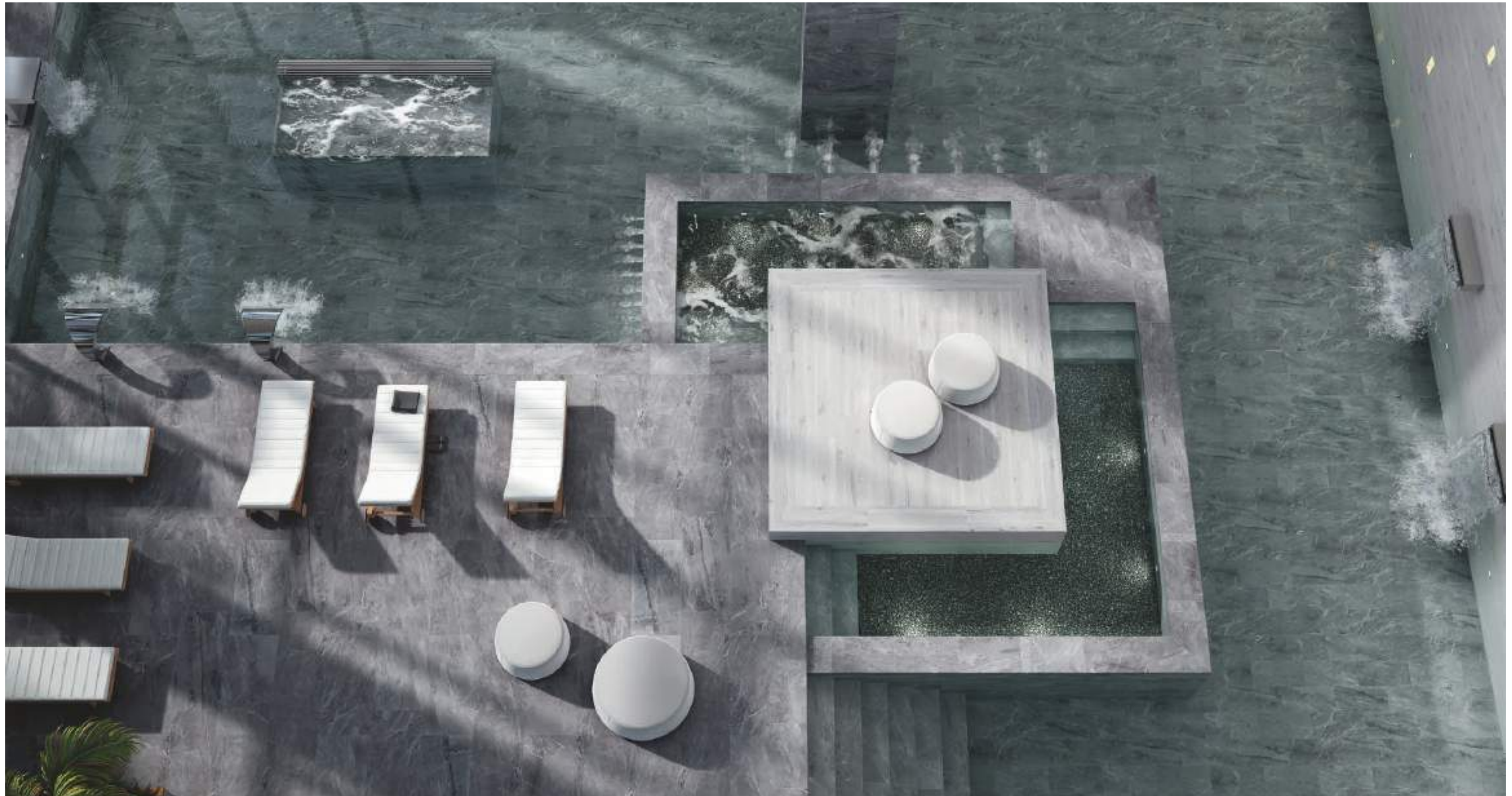



# IMPERIAL / MOCA

GRES EXTRUIDO · EXTRUDED KLINKER · GRÈS EXTRUDÉ · ЭКСТРУДИРОВАННЫЙ КЕРАМОГРАНИТ  
GRES PORCELÁNICO · PORCELAIN STONEWARE · GRÈS PORCELAINÉ · КЕРАМОГРАНИТ



R9 R11 C-1 C-3 CLASE C Alb <1,5% Bla <0,5% V2

FORMATOS · SIZES · FORMATS · ФОРМАТЫ

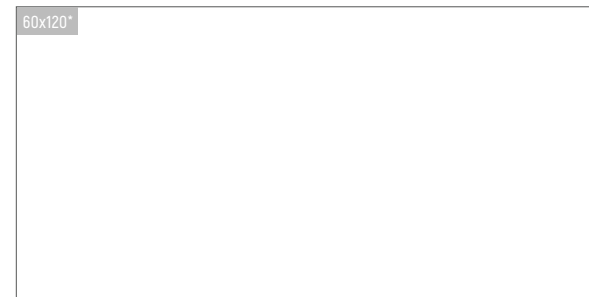
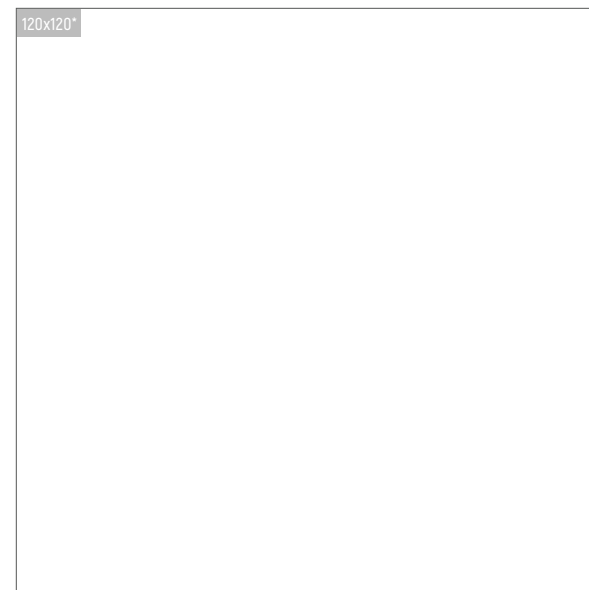

**120x120\***  
120 x 120 cm -  
47.2"x 47.2"

± 10 mm  
rectificado, rectified  
C-1/C-3

**60x120\***  
60 x 120 cm -  
23.7"x 47.2"

± 10 mm  
rectificado, rectified  
C-1/C-3

**14,5x120\***  
14,5 x 120 cm -  
5.7"x 47.2"

± 10 mm  
rectificado, rectified  
C-1

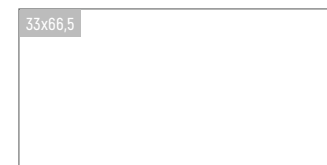
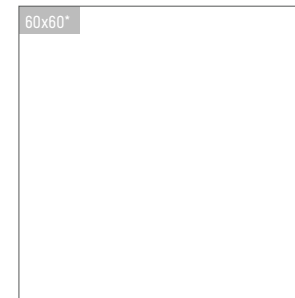

**60x60\***  
60 x 60 cm -  
23.7"x 23.7"

± 10,3 mm  
rectificado, rectified  
C-1

**33x66,5**  
33 x 66,5 cm -  
13.0"x 26.2"

± 10 mm  
C-1/C-3

PIEZAS ESPECIALES · SPECIAL PIECES · PIÈCES SPÉCIALES · СПЕЦИАЛЬНЫЕ ЭЛЕМЕНТЫ



**PELDAÑO RECTO 120**  
33 x 120 x 3 cm - 13.0"x 47.2"x 1.2"

± 12 mm  
rectificado, rectified  
C-1/C-3

**REMATE PELDAÑO RECTO**  
3 x 33 cm - 1.2"x 13.0"



**ZANQUÍN RECTO IZDA/DCHA**  
42,3 x 17,5 cm - 16.7"x 6.9"

± 7,5 mm



**PELDAÑO ML 120**  
33 x 120 x 4 cm - 13.0"x 47.2"x 1.6"

± 13 mm  
rectificado, rectified  
C-1

**REMATE ML**  
4 x 33 cm - 1.6"x 13.0"



**ZANQUÍN ML IZDA/DCHA**  
39,5 x 17,5 cm - 15.6"x 6.9"

± 7,5 mm

**RODAPIÉ**  
9 x 60 cm - 3.6"x 23.6"

± 11 mm

PIEZAS ESPECIALES · SPECIAL PIECES · PIÈCES SPÉCIALES · СПЕЦИАЛЬНЫЕ ЭЛЕМЕНТЫ

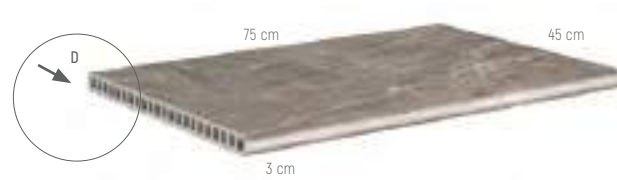

**BORDE SKIMMER**  
45 x 75 x 3 cm - 17.7" x 29.5" x 1.2"  
 rectificado, rectified  
 C-3



D. Continuidad gráfica, parte trasera.  
Graphic continuous, backside.



**BORDE DESBORDANTE**  
28 x 66,5 cm - 11.0" x 26.2"  
 rectificado, rectified  
 C-3



**ÁNGULO DESBORDANTE**  
31 x 31 cm - 12.2" x 12.2"  
 rectificado, rectified  
 C-3



**REJILLA**  
24,5 x 24,5 cm - 9.6" x 9.6"  
 rectificado, rectified  
 C-3



**ÁNGULO REJILLA DERECHA\***  
24,5 x 33 cm - 9.6" x 13.0"  
 rectificado, rectified  
 C-3



**ÁNGULO REJILLA IZQUIERDA\***  
24,5 x 33 cm - 9.6" x 13.0"  
 rectificado, rectified  
 C-3

\*set de 2 piezas [izda./dcha.] \*two pieces set [left/right]



**MEDIA CAÑA**  
33 x 4 cm - 13.0" x 1.6"  
r-3 cm



**UÑA**  
4 x 4 cm  
1.6" x 1.6"



**ÁNGULO EXTERIOR ARISTA**  
5 x 5 cm  
2" x 2"



**ARISTA**  
33 x 3 cm - 13.0" x 1.2"  
r-3 cm



**UÑA ARISTA**  
3 x 3 cm  
1.2" x 1.2"



**ÁNGULO INTERIOR ARISTA**  
5 x 5 cm  
2" x 2"

OUTDOOR: IMPERIAL MOCA 60x120 CM [C-3] - PELDAÑO RECTO 33x120x3 CM [C-3] - REMATE PELDAÑO RECTO 3x33 CM - TABICA 14,5x120 CM  
BORDE DESBORDANTE 28x66,5 CM [C-3] - REJILLA 28x28 CM [C-3] - IMPERIAL MOCA 33x66,5 CM [C-1] - MEDIA CAÑA 33x4 CM - UÑA 4x4 CM

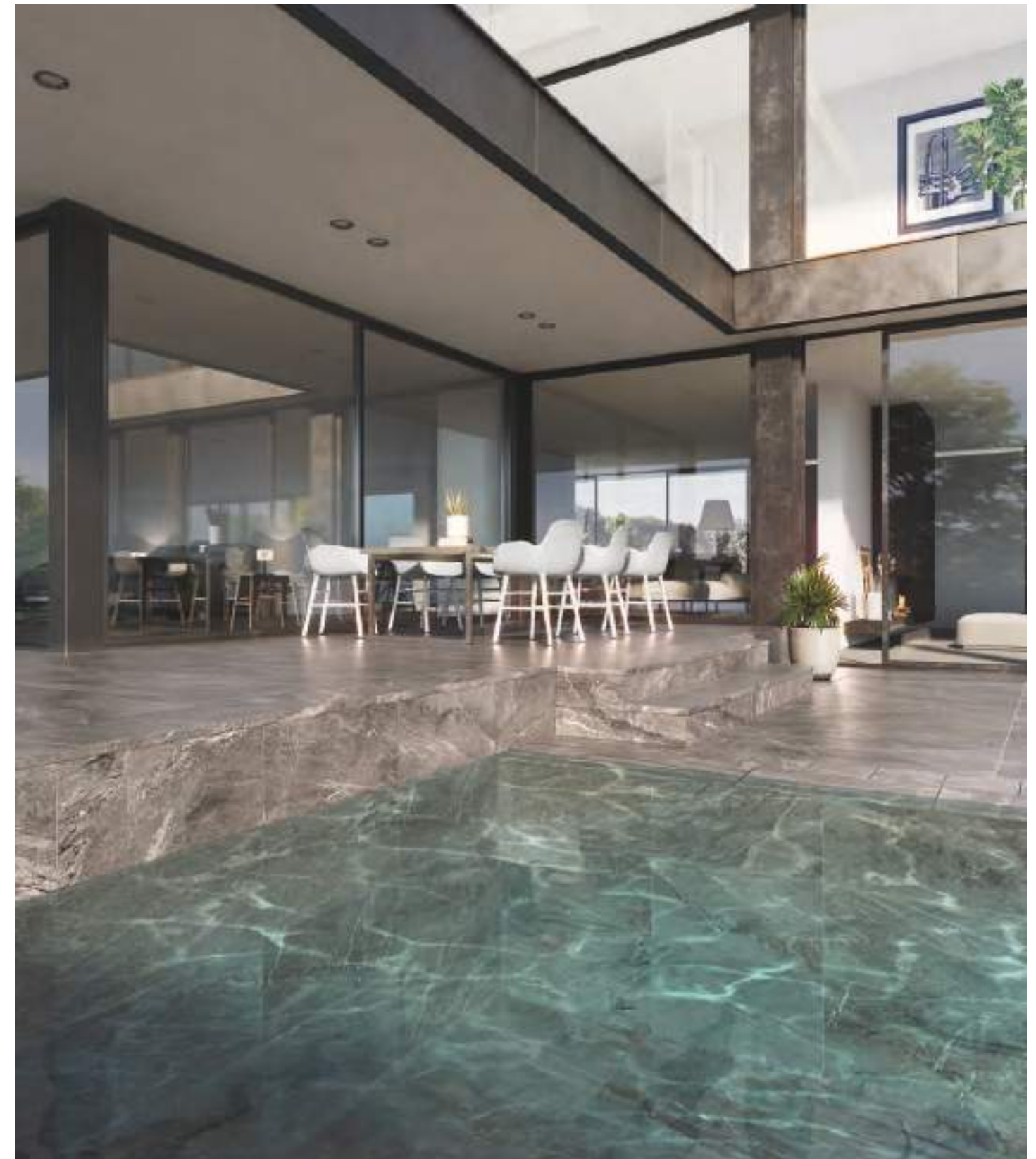



# IMPERIAL / MOCA



INDOOR: IMPERIAL MOCA 60x60 CM [C-1] - PELDAÑO ML 33x120x4 CM [C-1] - REMATE PELDAÑO ML 4x33 CM - TABICA 14,5x120 CM - ÓPERA IVORY 120x120 CM [C-1] / 60x120 CM [C-1] / 33x66,5 CM [C-1]

OUTDOOR: IMPERIAL MOCA 33x66,5 CM [C-3] - BORDE SKIMMER 45x75x3 CM [C-3] - IMPERIAL MOCA 33x66,5 CM [C-1]





# IMPERIAL / MOCA



OUTDOOR: IMPERIAL MOCA 60x120 CM [C-3] / 33x66,5 CM [C-1] - PELDAÑO RECTO 33x120x3 CM [C-3] - TABICA IMPERIAL MOCA 14,5x120 CM - BORDE DESBORDANTE 28x66,5 CM [C-3] -

REJILLA 24,5x24,5 CM [C-3]

INDOOR: IMPERIAL MOCA 60x120 CM [C-1]





# IMPERIAL / SIENA

GRES EXTRUIDO · EXTRUDED KLINKER · GRÈS EXTRUDÉ · ЭКСТРУДИРОВАННЫЙ КЕРАМОГРАНИТ  
GRES PORCELÁNICO · PORCELAIN STONEWARE · GRÈS PORCELAINÉ · КЕРАМОГРАНИТ

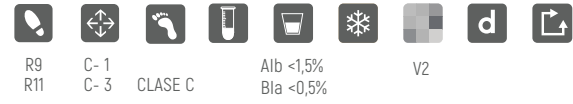

R9 R11 C-1 C-3 CLASE C Alb <1,5% Bla <0,5% V2

FORMATOS · SIZES · FORMATS · ФОРМАТЫ

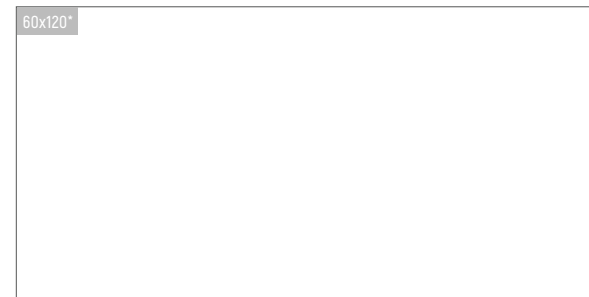
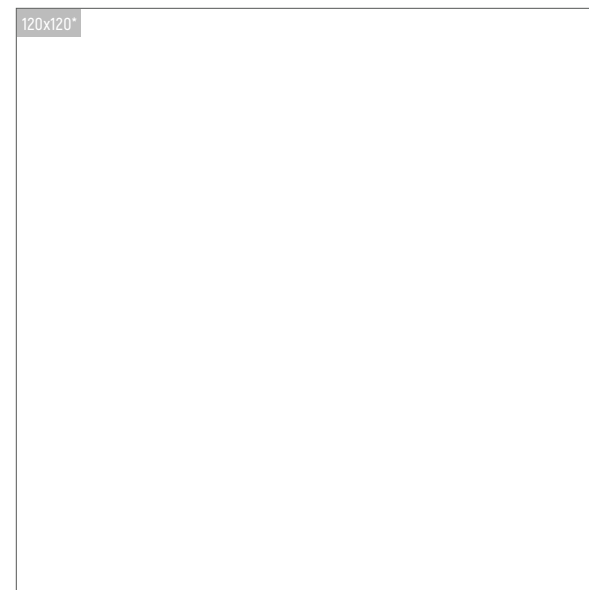

<p><b>120x120*</b> 120 x 120 cm - 47.2"x 47.2"</p> <p>10 mm rectificado, rectified C-1/C-3</p>	<p><b>60x120*</b> 60 x 120 cm - 23.7"x 47.2"</p> <p>10 mm rectificado, rectified C-1/C-3</p>	<p><b>14,5x120*</b> 14,5 x 120 cm - 5.7"x 47.2"</p> <p>10 mm rectificado, rectified C-1</p>
----------------------------------------------------------------------------------------------------------------	--------------------------------------------------------------------------------------------------------------	-------------------------------------------------------------------------------------------------------------

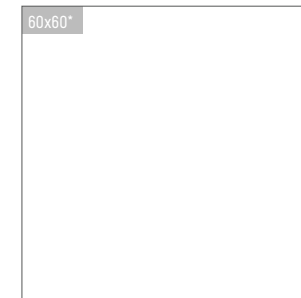

<p><b>60x60*</b> 60 x 60 cm - 23.7"x 23.7"</p> <p>10,3 mm rectificado, rectified C-1</p>	<p><b>33x66,5</b> 33 x 66,5 cm - 13.0"x 26.2"</p> <p>10 mm C-1/C-3</p>
----------------------------------------------------------------------------------------------------------	------------------------------------------------------------------------------------

PIEZAS ESPECIALES · SPECIAL PIECES · PIÈCES SPÉCIALES · СПЕЦИАЛЬНЫЕ ЭЛЕМЕНТЫ



**PELDAÑO RECTO 120**  
33 x 120 x 3 cm - 13.0"x 47.2"x 1.2"

12 mm  
rectificado, rectified  
C-1/C-3

**REMATE PELDAÑO RECTO**  
3 x 33 cm - 1.2"x 13.0"



**ZANQUÍN RECTO IZDA/DCHA**  
42,3 x 17,5 cm - 16.7"x 6.9"

7,5 mm



**PELDAÑO ML 120**  
33 x 120 x 4 cm - 13.0"x 47.2"x 1.6"

13 mm  
rectificado, rectified  
C-1

**REMATE ML**  
4 x 33 cm - 1.6"x 13.0"



**ZANQUÍN ML IZDA/DCHA**  
39,5 x 17,5 cm - 15.6"x 6.9"

7,5 mm

**RODAPIÉ**  
9 x 60 cm - 3.6"x 23.6"

11 mm

PIEZAS ESPECIALES · SPECIAL PIECES · PIÈCES SPÉCIALES · СПЕЦИАЛЬНЫЕ ЭЛЕМЕНТЫ



**BORDE SKIMMER**  
45 x 75 x 3 cm - 17.7" x 29.5" x 1.2"

rectificado, rectified  
C-3



D. Continuidad gráfica, parte trasera.  
Graphic continuous, backside.



**BORDE DESBORDANTE**  
28 x 66,5 cm - 11.0" x 26.2"

rectificado, rectified  
C-3



**ÁNGULO DESBORDANTE**  
31 x 31 cm - 12.2" x 12.2"

rectificado, rectified  
C-3



**REJILLA**  
24,5 x 24,5 cm - 9.6" x 9.6"

rectificado, rectified  
C-3



**ÁNGULO REJILLA DERECHA\***  
24,5 x 33 cm - 9.6" x 13.0"

rectificado, rectified  
C-3



**ÁNGULO REJILLA IZQUIERDA\***  
24,5 x 33 cm - 9.6" x 13.0"

rectificado, rectified  
C-3

\*set de 2 piezas [izda./dcha.] \*two pieces set [left/right]



**MEDIA CAÑA**  
33 x 4 cm - 13.0" x 1.6"  
r-3 cm



**UÑA**  
4 x 4 cm  
1.6" x 1.6"



**ÁNGULO EXTERIOR ARISTA**  
5 x 5 cm  
2" x 2"



**ARISTA**  
33 x 3 cm - 13.0" x 1.2"  
r-3 cm



**UÑA ARISTA**  
3 x 3 cm  
1.2" x 1.2"



**ÁNGULO INTERIOR ARISTA**  
5 x 5 cm  
2" x 2"





# IMPERIAL / SIENA

exagres  
TECHNICAL SOLUTIONS

IMPERIAL SIENA 120x120 CM [C-3] / 60x120 CM [C-1] / 33x66,5 CM [C-1] - PELDAÑO RECTO 120 33x120x3 CM [C-3] - TABICA 14,5x120 CM - BORDE SKIMMER 45x75x3 CM [C-3]

YOHO TECA 25x150 CM [C-3]





# IMPERIAL / SIENA

OUTDOOR: IMPERIAL SIENA 60x120 CM [C-3] - YOHO OAK 25x150 CM [C-3]

INDOOR: IMPERIAL SIENA 120x120 CM [C-1] - PELDAÑO RECTO 33x120x3 CM [C-3] - TABICA IMPERIAL SIENA 14,5x120 CM - OPERA IRON 120x120 CM [C-1]



MARBLE



# VENATTO

NEUTRAL AND CONTEMPORARY MARBLE  
IN&OUTDOOR  
STAIRS  
SWIMMINGPOOLS

COLORS:	SIZES (cm):	SIZES (inches):
PERLA	120x120 cm	47.2"x47.2"
	60x120 cm	23.7"x47.2"
	14,5x120 cm	5.7"x47.2"
	33x66,5 cm	13.0"x26.2"



INDOOR: VENATTO PERLA 120x120 CM [C-1]

OUTDOOR: VENATTO PERLA 120x120 CM [C-3] - PELDAÑO ML 33x120x4 CM [C-3]



# VENATTO / PERLA

exagres  
TECHNICAL SOLUTIONS

GRES EXTRUIDO · EXTRUDED KLINKER · GRÈS EXTRUDÉ · ЭКСТРУДИРОВАННЫЙ КЕРАМОГРАНИТ  
GRES PORCELÁNICO · PORCELAIN STONEWARE · GRÈS PORCELAINÉ · КЕРАМОГРАНИТ



R9 C-1 Alb <1.5% V1  
R11 C-3 CLASE C Bla <0.5%

FORMATOS · SIZES · FORMATS · ФОРМАТЫ

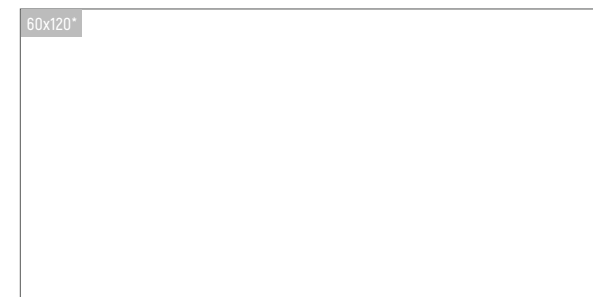
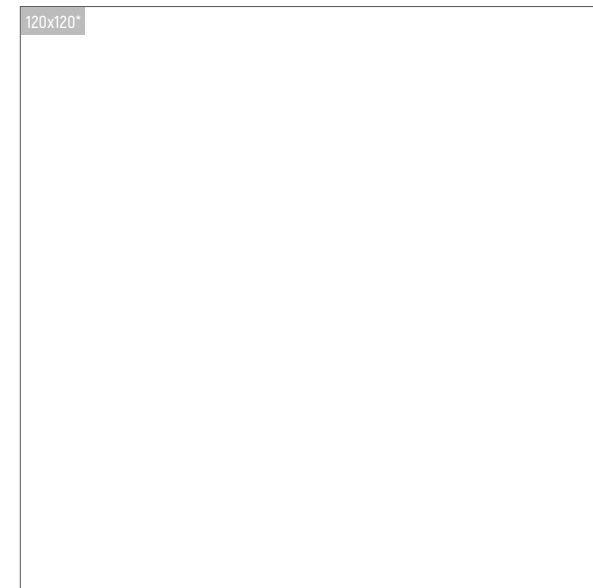

<p><b>120x120*</b> 120 x 120 cm - 47.2"x 47.2"</p> <p>10 mm rectificado, rectified C-1/C-3</p>	<p><b>60x120*</b> 60 x 120 cm - 23.7"x 47.2"</p> <p>10 mm rectificado, rectified C-1/C-3</p>	<p><b>14,5x120*</b> 14,5 x 120 cm - 5.7"x 47.2"</p> <p>10 mm rectificado, rectified C-1</p>	<p><b>33x66,5</b> 33 x 66,5 cm - 13.0"x 26.2"</p> <p>10 mm rectificado, rectified C-1/C-3</p>
----------------------------------------------------------------------------------------------------------------	--------------------------------------------------------------------------------------------------------------	-------------------------------------------------------------------------------------------------------------	---------------------------------------------------------------------------------------------------------------

PIEZAS ESPECIALES · SPECIAL PIECES · PIÈCES SPÉCIALES · СПЕЦИАЛЬНЫЕ ЭЛЕМЕНТЫ



**PELDAÑO ML 120**  
33 x 120 x 4 cm - 13.0"x 47.2"x 1.6"  
13 mm  
rectificado, rectified  
C-1/C-3



**REMATE ML**  
4 x 33 cm - 1.6"x 13.0"  
11 mm



**ZANQUÍN ML IZDA/DCHA**  
39,5 x 17,5 cm - 15.6"x 6.9"  
7,5 mm



**BORDE SKIMMER**  
45 x 75 x 3 cm - 17.7"x 29.5"x 1.2"  
rectificado, rectified  
C-3



D. Continuidad gráfica, parte trasera.  
Graphic continuous, backside.

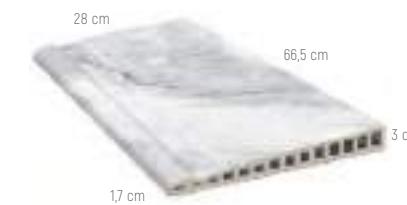

**BORDE DESBORDANTE**  
28 x 66,5 cm - 11.0"x 26.2"  
rectificado, rectified  
C-3



**ÁNGULO DESBORDANTE**  
31 x 31 cm - 12.2"x 12.2"  
rectificado, rectified  
C-3



**REJILLA**  
24,5 x 24,5 cm - 9.6"x 9.6"  
rectificado, rectified  
C-3



**ÁNGULO REJILLA DERECHA\***  
24,5 x 33 cm - 9.6"x 13.0"  
rectificado, rectified  
C-3



**ÁNGULO REJILLA IZQUIERDA\***  
24,5 x 33 cm - 9.6"x 13.0"  
rectificado, rectified  
C-3

\*set de 2 piezas [izda./dcha.] \*two pieces set [left/right]



**MEDIA CAÑA**  
33 x 4 cm - 13.0"x 1.6"  
r-3 cm



**UÑA**  
4 x 4 cm  
1.6"x 1.6"



**ÁNGULO EXTERIOR ARISTA**  
5 x 5 cm  
2"x 2"



**ARISTA**  
33 x 3 cm - 13.0"x 1.2"  
r-3 cm



**UÑA ARISTA**  
3 x 3 cm  
1.2"x 1.2"



**ÁNGULO INTERIOR ARISTA**  
5 x 5 cm  
2"x 2"

\* GRES PORCELÁNICO · PORCELAIN STONEWARE · GRÈS PORCELAINÉ · КЕРАМОГРАНИТ

# VENATTO / PERLA



OUTDOOR: VENATTO PERLA 60x120 CM [C-3] / 120x120 CM [C-3] - BORDE SKIMMER 45x75x3 CM [C-3]

WALL: OROBICO TAUPE 60x120 CM [C-1]

INDOOR: VENATTO PERLA 120x120 CM [C-1] - PELDAÑO ML 33x120x4 CM [C-1]





# VENATTO / PERLA



OUTDOOR: VENATTO PERLA 120x120 CM [C-3] - BORDE SKIMMER 45x75x3 CM [C-3] - VENATTO PERLA 33x66,5 CM [C-1] - MEDIA CAÑA 33x4 CM - UÑA 4x4 CM - PELDAÑO ML 33x120x4 CM [C-1]

WALL: OROBICO TAUPE 60x120 CM [C-1]





# VENATTO / PERLA

VENATTO PERLA 60x120 CM [C-1] - PELDAÑO ML 120 PERLA 33x120x4 CM [C-1] - TABICA VENATTO PERLA 14,5x120 CM [C-1]





# VENATTO / PERLA

VENATTO PERLA 120x120 CM [C-3] / 60x120 CM [C-1] - BORDE DESORDANTE 28x66,5 CM [C-3] - REJILLA 24,5x24,5 CM [C-3] - PELDAÑO ML 33x120x4 CM [C-3] -

YOHO TECA 25x150 CM [C-1 / C-3] - PELDAÑO ML 33x120x3 CM [C-3] - TABICA 14,5x120 CM



# VENATTO / PERLA



INDOOR: VENATTO PERLA 120x120 CM (C-1) - PELDAÑO ML 33x120x4 CM (C-1) - TABICA VENATTO PERLA 12,5x120 CM -

ÓPERA SILVER 60x120 CM (C-1)

OUTDOOR: VENATTO PERLA 120x120 CM (C-3)





MARBLE



# NUBIA

PURE BRUTALIST STYLE  
IN&OUTDOOR  
LARGE FORMATS  
STAIRS  
SWIMMINGPOOLS



COLORS:      SIZES (cm):      SIZES (inches):

NUBIA      60x120 cm      23,7"x47.2"  
              33x66,5 cm      13.0"x26.2"

NUBIA 60x120 CM [C-1] - NUBIA 33x66,5 CM [C-1] - PELDAÑO RECTO 33x120x3 CM [C-3] - YOHO MAPLE 25x150 CM [C-3] - PELDAÑO RECTO 33x120x3 CM [C-3]  
ÓPERA IVORY 120x120 CM [C-3] - BORDE DESBORDANTE 28x66,5 CM [C-3] - REJILLA 24,5x24,5 CM [C-3]

# NUBIA / NUBIA



GRES EXTRUIDO · EXTRUDED KLINKER · GRÈS EXTRUDÉ · ЭКСТРУДИРОВАННЫЙ КЕРАМОГРАНИТ  
GRES PORCELÁNICO · PORCELAIN STONEWARE · GRÈS PORCELAINÉ · КЕРАМОГРАНИТ



R9 C-1 Alb <1,5% V3  
R11 C-3 CLASE C Bla <0,5%



FORMATOS · SIZES · FORMATS · ФОРМАТЫ

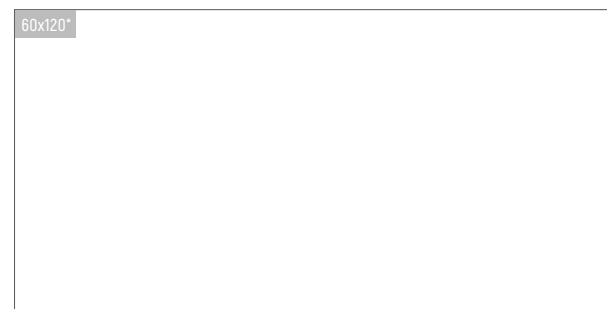
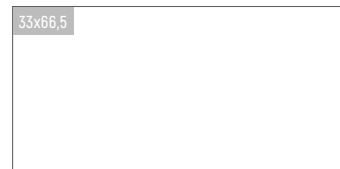

**60x120\***  
60 x 120 cm -  
23.7"x 47.2"

12 mm  
rectificado, rectified  
C-1/C-3

**33x66,5**  
33 x 66,5 cm -  
13.0"x 26.2"

10 mm  
C-1/C-3

PIEZAS ESPECIALES · SPECIAL PIECES · PIÈCES SPÉCIALES · СПЕЦИАЛЬНЫЕ ЭЛЕМЕНТЫ



**PELDAÑO RECTO 120**  
33 x 120 x 3 cm - 13.0"x 47.2"x 1.2"

12 mm  
rectificado, rectified  
C-1/C-3



**MEDIA CAÑA**  
33 x 4 cm - 13.0"x 1.6"  
r-3 cm



**UÑA**  
4 x 4 cm - 1.6"x 1.6"



**ARISTA**  
33 x 3 cm - 13.0"x 1.2"  
r-3 cm



**UÑA ARISTA**  
3 x 3 cm - 1.2"x 1.2"



# NUBIA / NUBIA

OUTDOOR: NUBIA 60x120 CM (C-3)

INDOOR: NUBIA 60x120 CM (C-1) - YOHO MAPLE 25x150 CM (C-1)





# NUBIA / NUBIA

OUTDOOR: NUBIA 60x120 CM (C-1) - NUBIA 33x66,5 CM (C-1) - PELDAÑO RECTO 33x120x3 CM (C-3)

YOHO MAPLE 25x150 CM (C-3) - PELDAÑO RECTO 33x120x3 CM (C-3) - ÓPERA IVORY 120x120 CM (C-3) - BORDE DESBORDANTE 28x66,5 CM (C-3) - REJILLA 24,5x24,5 CM (C-3)





# NUBIA / NUBIA

INDOOR: NUBIA 60x120 CM (C-1) - PELDAÑO RECTO 33x120x3 CM (C-1) - TABICA NUBIA 14,5x120 CM (C-1)

OUTDOOR: NUBIA 60x120 CM (C-3)





MARBLE

exagres  
TECHNICAL SOLUTIONS

# OROBICO

DYNAMIC AND ELEGANT MARBLE  
INDOOR  
STAIRS

COLORS:      SIZES (cm):      SIZES (inches):

GRIS	60x120 cm	23.7"x47.2"
TAUPE	14,5x120 cm	5.7"x47.2"



OROBICO GRIS 60x120 CM [C-1] - PELDAÑO ML 33x120x4 CM [C-1] - TABICA OROBICO GRIS 14,5x120 CM [C-1] - RODAPIÉ 9x60 CM - ZANQUÍN ML 39,5x17,5 CM

# OROBICO / GRIS

GRES EXTRUIDO · EXTRUDED KLINKER · GRÈS EXTRUDÉ · ЭКСТРУДИРОВАННЫЙ КЕРАМОГРАНИТ  
GRES PORCELÁNICO · PORCELAIN STONEWARE · GRÈS PORCELAINÉ · КЕРАМОГРАНИТ

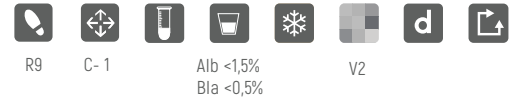

FORMATOS · SIZES · FORMATS · ФОРМАТЫ

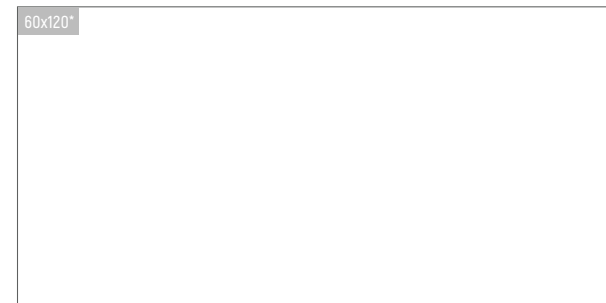

<p><b>60x120*</b> 60 x 120 cm - 23.7"x 47.2"</p> <p>± 10,2 mm   rectificado. rectified   C-1</p>	<p><b>14,5x120*</b> 14,5 x 120 cm - 5.7"x 47.2"</p> <p>± 10,2 mm   rectificado. rectified   C-1</p>
--------------------------------------------------------------------------------------------------------------	-----------------------------------------------------------------------------------------------------------------

\* GRES PORCELÁNICO · PORCELAIN STONEWARE · GRÈS PORCELAINÉ · КЕРАМОГРАНИТ

PIEZAS ESPECIALES · SPECIAL PIECES · PIÈCES SPÉCIALES · СПЕЦИАЛЬНЫЕ ЭЛЕМЕНТЫ



**PELDAÑO ML 120**  
33 x 120 x 4 cm - 13.0"x 47.2"x 1.6"

± 13 mm  
 rectificado. rectified  
 C-1

**REMATE ML**  
4 x 33 cm - 1.6"x 13.0"



**ZANQUÍN ML IZDA/DCHA**  
39,5 x 17,5 cm - 15.6"x 6.9"

± 7,5 mm



**RODAPIÉ**  
9 x 60 cm - 3,6"x 23.6"

± 11 mm



# OROBICO / GRIS

OROBICO GRIS 60x120 CM [C-1] - PELDAÑO ML 33x120x4 CM [C-1] - TABICA OROBICO GRIS 14,5x120 CM [C-1] -

YOHO NATURAL 25x150 CM [C-1]





# OROBICO / GRIS

OROBICO GRIS 60x120 CM [C-1] - PELDAÑO ML 33x120x4 CM [C-1] - TABICA OROBICO GRIS 14,5x120 CM [C-1]





# OROBICO / TAUPE

GRES EXTRUIDO · EXTRUDED KLINKER · GRÈS EXTRUDÉ · ЭКСТРУДИРОВАННЫЙ КЕРАМОГРАНИТ  
GRES PORCELÁNICO · PORCELAIN STONEWARE · GRÈS PORCELAINÉ · КЕРАМОГРАНИТ

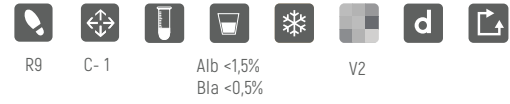

FORMATOS · SIZES · FORMATS · ФОРМАТЫ

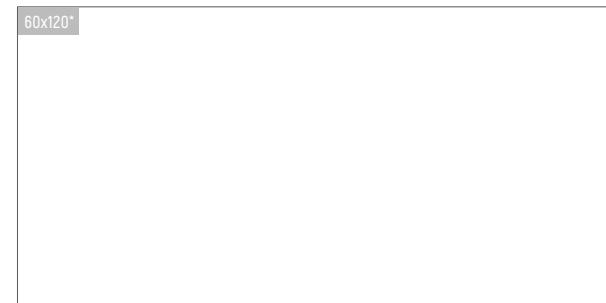

<p><b>60x120*</b> 60 x 120 cm - 23.7"x 47.2"</p> <p>± 10,2 mm   rectificado. rectified   C-1</p>	<p><b>14,5x120*</b> 14,5 x 120 cm - 5.7"x 47.2"</p> <p>± 10,2 mm   rectificado. rectified   C-1</p>
--------------------------------------------------------------------------------------------------------------	-----------------------------------------------------------------------------------------------------------------

\* GRES PORCELÁNICO · PORCELAIN STONEWARE · GRÈS PORCELAINÉ · КЕРАМОГРАНИТ

PIEZAS ESPECIALES · SPECIAL PIECES · PIÈCES SPÉCIALES · СПЕЦИАЛЬНЫЕ ЭЛЕМЕНТЫ



**PELDAÑO ML 120**  
33 x 120 x 4 cm - 13.0"x 47.2"x 1.6"

± 13 mm  
 rectificado. rectified  
 C-1

**REMATE ML**  
4 x 33 cm - 1.6"x 13.0"



**ZANQUÍN ML IZDA/DCHA**  
39,5 x 17,5 cm - 15.6"x 6.9"

± 7,5 mm



**RODAPIÉ**  
9 x 60 cm - 3,6"x 23.6"

± 11 mm



# OROBICO / TAUPE

OROBICO TAUPE 60x120 CM [C-1] - PELDAÑO ML 33x120x4 CM [C-1] - TABICA OROBICO TAUPE 14,5x120 CM [C-1] - REMATE ML 4x33 CM.





# OROBICO / TAUPE

OROBICO TAUPE 60x120 CM [C-1] - PELDAÑO ML 33x120x4 CM [C-1] - TABICA OROBICO TAUPE 14,5x120 CM [C-1] - REMATE ML 4x33 CM.





MARBLE



# MARBLES

ELEGANCE & TIMELESSNESS  
IN & OUTDOOR  
STAIRS  
SWIMMING POOLS

COLORS:	SIZES (cm):	SIZES (inches):
CALACATTA	60x120 cm	23.7"x47.2"
TRAVERTINO	14,5x120 cm	5.7"x47.2"
CREMA MARFIL	33x66,5 cm	13.0"x26.2"



TRAVERTINO 60x120 CM (C-1)



# MARBLES / CALACATTA



GRES EXTRUIDO · EXTRUDED KLINKER · GRÈS EXTRUDÉ · ЭКСТРУДИРОВАННЫЙ КЕРАМОГРАНИТ  
 \*GRES PORCELÁNICO · PORCELAIN STONEWARE · GRÈS PORCELAINÉ · КЕРАМОГРАНИТ

R9  
 C-1  
 CLASE C  
 Alb <1,5%  
 Bla <0,5%  
 V1  
 d



FORMATOS · SIZES · FORMATS · ФОРМАТЫ

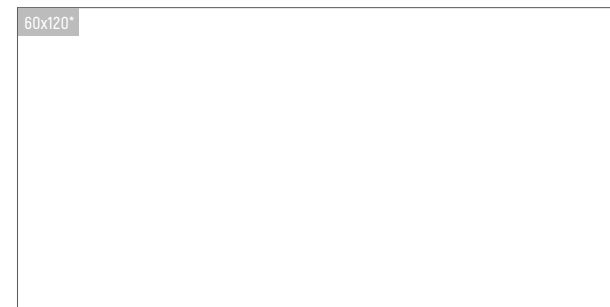

<b>60x120*</b> 60 x 120 cm - 23.7"x 47.2" x 10,2 mm rectificado, rectified C-1	<b>14,5x120*</b> 14,5 x 120 cm - 5.7"x 47.2" x 10,2 mm rectificado, rectified C-1	<b>33x66,5</b> 33 x 66,5 cm - 13.0"x 26.2" x 10 mm C-1/C-3
--------------------------------------------------------------------------------------------	-----------------------------------------------------------------------------------------------	---------------------------------------------------------------------

PIEZAS ESPECIALES · SPECIAL PIECES · PIÈCES SPÉCIALES · СПЕЦИАЛЬНЫЕ ЭЛЕМЕНТЫ



**PELDAÑO RECTO 120**  
 33 x 120 x 3 cm - 13.0"x 47.2"x 1.2"  
 x 12 mm  
 rectificado, rectified  
 C-3

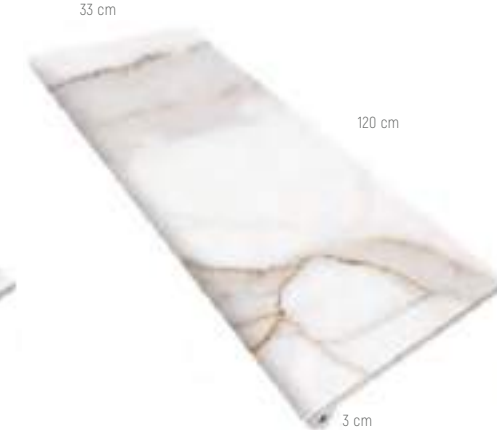

**PELDAÑO FIORENTINO 120**  
 33 x 120 x 3 cm - 13.0"x 47.2"x 1.2"  
 x 12 mm  
 rectificado, rectified  
 C-1



**PELDAÑO RECTO 60**  
 33 x 60 x 3 cm - 13.0"x 23.7"x 1.2"  
 x 12 mm  
 rectificado, rectified  
 C-3



**REMATE PELDAÑO RECTO**  
 3 x 33 cm - 1.2"x 13.0"



**REMATE PELDAÑO FIORENTINO IZDA/DCHA**  
 3 x 33 cm - 1.2"x 13.0"



**ZANQUÍN RECTO IZDA/DCHA**  
 40 x 18 cm - 15.7"x 7.1"  
 x 15 mm



**ZANQUÍN FIORENTINO IZDA/DCHA**  
 40 x 18 cm - 15.7"x 7.1"  
 x 15 mm



**RODAPIÉ**  
 9 x 40 cm - 3.5"x 15.7"  
 x 15 mm



**MEDIA CAÑA**  
 33 x 4 cm - 13.0"x 1.6"  
 r-3 cm



**UÑA**  
 4 x 4 cm - 1.6"x 1.6"



**ARISTA**  
 33 x 3 cm - 13.0"x 1.2"  
 r-3 cm



**UÑA ARISTA**  
 3 x 3 cm - 1.2"x 1.2"

\*GRES PORCELÁNICO · PORCELAIN STONEWARE · GRÈS PORCELAINÉ · КЕРАМОГРАНИТ

# MARBLES / CALACATTA

OUTDOOR: MARBLES CALACATTA 33x66,5 CM [C-3] - PELDAÑO RECTO 33x60x3 CM [C-3]



OUTDOOR: MARBLES CALACATTA 33x66,5 CM [C-3] - PELDAÑO RECTO 33x60x3 CM [C-3] - MEDIA CAÑA 33x4 CM - UÑA 4x4 CM

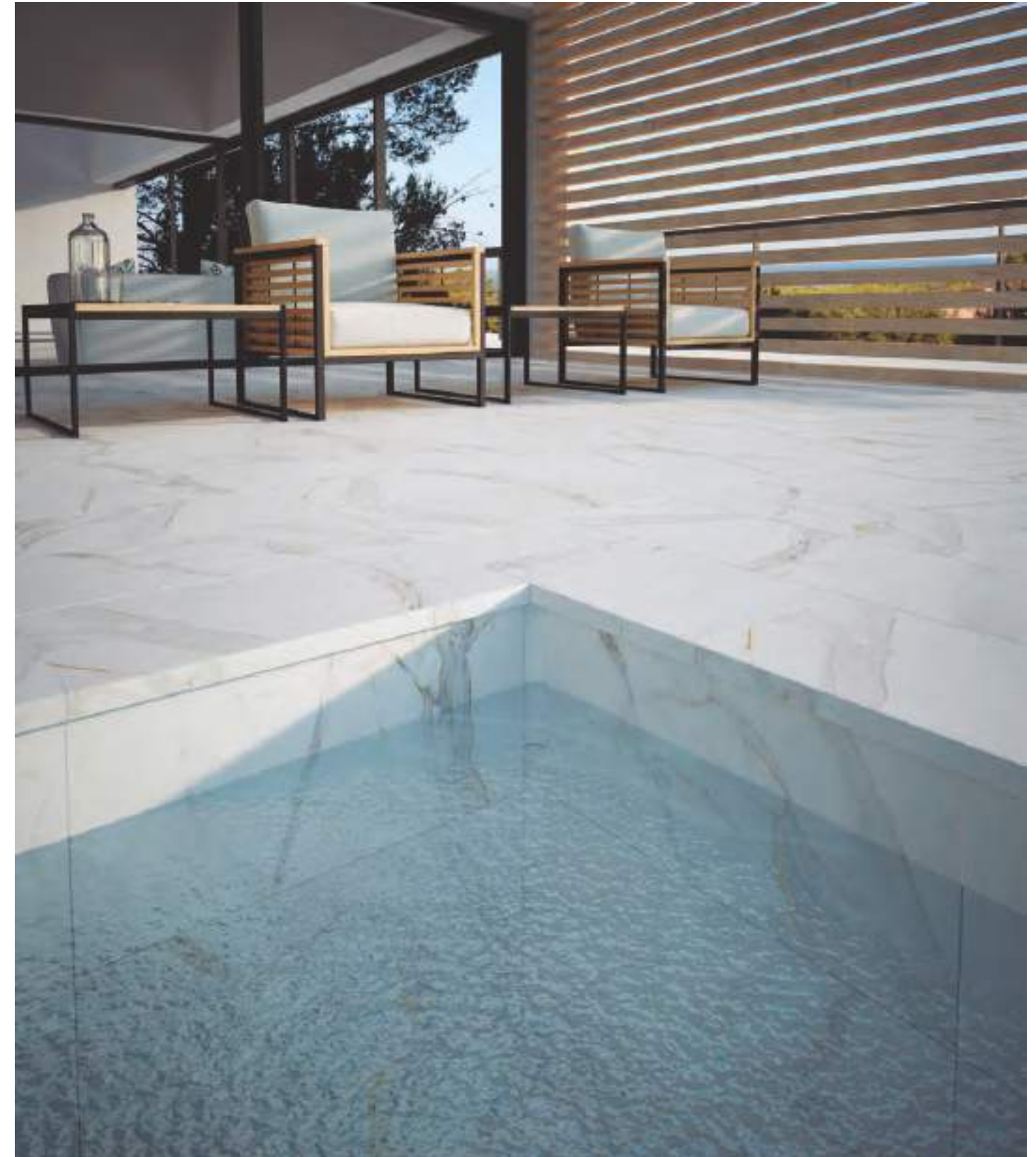



# MARBLES / TRAVERTINO

GRES EXTRUIDO · EXTRUDED KLINKER · GRÈS EXTRUDÉ · ЭКСТРУДИРОВАННЫЙ КЕРАМОГРАНИТ  
GRES PORCELÁNICO · PORCELAIN STONEWARE · GRÈS PORCELAINÉ · КЕРАМОГРАНИТ



R9 R11 C-1 C-3 CLASE C Alb <1.5% Bla <0.5% V1



FORMATOS · SIZES · FORMATS · ФОРМАТЫ

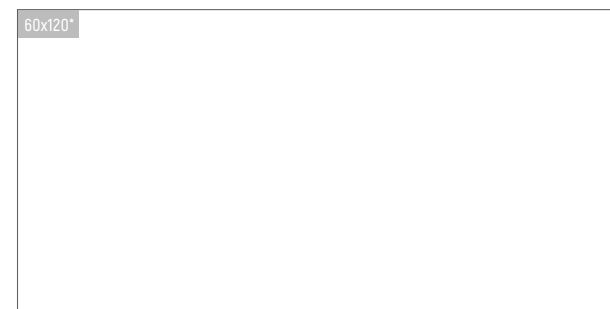

<b>60x120*</b> 60 x 120 cm - 23.7"x 47.2"	<b>14,5x120*</b> 14,5 x 120 cm - 5.7"x 47.2"	<b>33x66,5</b> 33 x 66,5 cm - 13.0"x 26.2"
± 10,2 mm rectificado, rectified C-1	± 10,2 mm rectificado, rectified C-1	± 10 mm C-1/C-3

PIEZAS ESPECIALES · SPECIAL PIECES · PIÈCES SPÉCIALES · СПЕЦИАЛЬНЫЕ ЭЛЕМЕНТЫ



**PELDAÑO RECTO 120**  
33 x 120 x 3 cm - 13.0"x 47.2"x 1.2"  
± 12 mm  
rectificado, rectified  
C-3



**PELDAÑO FIORENTINO 120**  
33 x 120 x 3 cm - 13.0"x 47.2"x 1.2"  
± 12 mm  
rectificado, rectified  
C-1



**PELDAÑO RECTO 60**  
33 x 60 x 3 cm - 13.0"x 23.7"x 1.2"  
± 12 mm  
rectificado, rectified  
C-3



**REMATE PELDAÑO RECTO**  
3 x 33 cm - 1.2"x 13.0"



**REMATE PELDAÑO FIORENTINO IZDA/DCHA**  
3 x 33 cm - 1.2"x 13.0"



**ZANQUÍN RECTO IZDA/DCHA**  
40 x 18 cm - 15.7"x 7.1"  
± 15 mm



**ZANQUÍN FIORENTINO IZDA/DCHA**  
40 x 18 cm - 15.7"x 7.1"  
± 15 mm



**RODAPIÉ**  
9 x 40 cm - 3.5"x 15.7"  
± 15 mm



**MEDIA CAÑA**  
33 x 4 cm - 13.0"x 1.6"  
r-3 cm



**UÑA**  
4 x 4 cm - 1.6"x 1.6"



**ARISTA**  
33 x 3 cm - 13.0"x 1.2"  
r-3 cm



**UÑA ARISTA**  
3 x 3 cm - 1.2"x 1.2"

\* GRES PORCELÁNICO · PORCELAIN STONEWARE · GRÈS PORCELAINÉ · КЕРАМОГРАНИТ

# MARBLES / CREMA MARFIL

exagres  
TECHNICAL SOLUTIONS

GRES EXTRUIDO · EXTRUDED KLINKER · GRÈS EXTRUDÉ · ЭКСТРУДИРОВАННЫЙ КЕРАМОГРАНИТ  
GRES PORCELÁNICO · PORCELAIN STONEWARE · GRÈS PORCELAINÉ · КЕРАМОГРАНИТ



R9 C-1 Alb <1,5% V1  
R11 C-3 CLASE C Bla <0,5%

FORMATOS · SIZES · FORMATS · ФОРМАТЫ

PIEZAS ESPECIALES · SPECIAL PIECES · PIÈCES SPÉCIALES · СПЕЦИАЛЬНЫЕ ЭЛЕМЕНТЫ

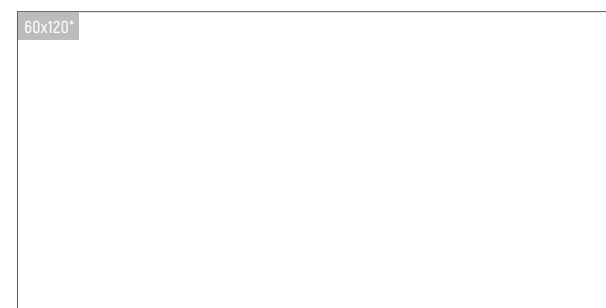
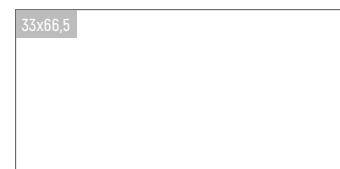

<b>60x120*</b> 60 x 120 cm - 23.7"x 47.2"	<b>14,5x120*</b> 14,5 x 120 cm - 5.7"x 47.2"	<b>33x66,5</b> 33 x 66,5 cm - 13.0"x 26.2"
± 10,2 mm rectificado, rectified C-1	± 10,2 mm rectificado, rectified C-1	± 10 mm C-1/C-3



**PELDAÑO RECTO 120**  
33 x 120 x 3 cm - 13.0"x 47.2"x 1.2"  
± 12 mm  
rectificado, rectified  
C-3



**PELDAÑO FIORENTINO 120**  
33 x 120 x 3 cm - 13.0"x 47.2"x 1.2"  
± 12 mm  
rectificado, rectified  
C-1



**PELDAÑO RECTO 60**  
33 x 60 x 3 cm - 13.0"x 23.7"x 1.2"  
± 12 mm  
rectificado, rectified  
C-3



**REMATE PELDAÑO RECTO**  
3 x 33 cm - 1.2"x 13.0"



**REMATE PELDAÑO FIORENTINO IZDA/DCHA**  
3 x 33 cm - 1.2"x 13.0"



**ZANQUÍN RECTO IZDA/DCHA**  
40 x 18 cm - 15.7"x 7.1"  
± 15 mm



**ZANQUÍN FIORENTINO IZDA/DCHA**  
40 x 18 cm - 15.7"x 7.1"  
± 15 mm



**RODAPIÉ**  
9 x 40 cm - 3.5"x 15.7"  
± 15 mm



**MEDIA CAÑA**  
33 x 4 cm - 13.0"x 1.6"  
r-3 cm



**UÑA**  
4 x 4 cm - 1.6"x 1.6"



**ARISTA**  
33 x 3 cm - 13.0"x 1.2"  
r-3 cm



**UÑA ARISTA**  
3 x 3 cm - 1.2"x 1.2"

\* GRES PORCELÁNICO · PORCELAIN STONEWARE · GRÈS PORCELAINÉ · КЕРАМОГРАНИТ



# MARBLES / TRAVERTINO

OUTDOOR: TRAVERTINO 33x66,5 CM [C-3] - PELDAÑO RECTO 33x120x3 CM [C-3] / 33x60x3 CM [C-3] - TABICA 14,5x120 CM - MEDIA CAÑA 33x4 CM

FAÇADE: TRAVERTINO 33x66,5 CM [C-1]



# MARBLES / CREMA MARFIL

INDOOR: CREMA MARFIL 60x120 CM [C-1] - PELDAÑO RECTO 33x120x3 CM [C-3] - TABICA 14,5x120 CM



MARBLE



# MARKINA

MODERN GRAPHIC MARBLE  
LARGE FORMAT  
STAIRS



COLORS:      SIZES (cm):      SIZES (inches):

BIANCO	62x120 cm	24.4"x47.2"
NERO	14,5x120 cm	5.7"x47.2"

MARKINA NERO 62x120 CM [C-1] - TABICA 14,5x120 CM - PELDAÑO RECTO 33x120x3 CM [C-1] - MARKINA BIANCO 62x120 CM [C-1]



# MARKINA / BIANCO

GRES EXTRUIDO · EXTRUDED KLINKER · GRÈS EXTRUDÉ · ЭКСТРУДИРОВАННЫЙ КЕРАМОГРАНИТ  
 \*GRES PORCELÁNICO · PORCELAIN STONEWARE · GRÈS PORCELAINÉ · КЕРАМОГРАНИТ



R9 C-1 Alb <1,5% V1  
 R11 C-3 Bla <0,5%



FORMATOS · SIZES · FORMATS · ФОРМАТЫ

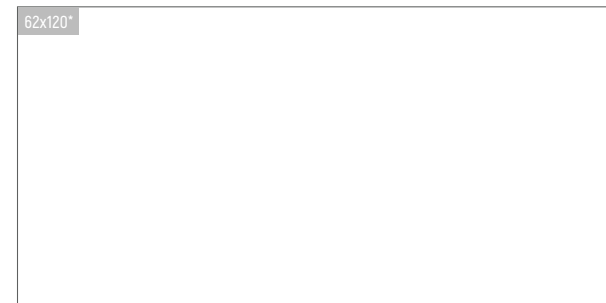

**62x120\***  
 62 x 120 cm - 24.4"x 47.2"

± 11 mm  
 rectificado, rectified  
 C-1/C-3

**14,5x120\***  
 14,5 x 120 cm - 5.7"x 47.2"

± 11 mm  
 rectificado, rectified  
 C-1

\* GRES PORCELÁNICO · PORCELAIN STONEWARE · GRÈS PORCELAINÉ · КЕРАМОГРАНИТ

PIEZAS ESPECIALES · SPECIAL PIECES · PIÈCES SPÉCIALES · СПЕЦИАЛЬНЫЕ ЭЛЕМЕНТЫ

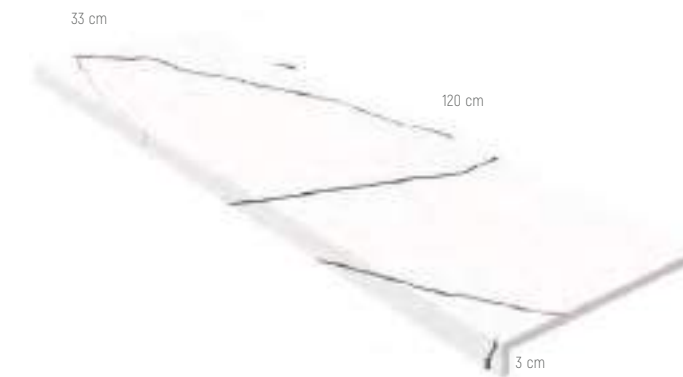

**PELDAÑO RECTO 120**  
 33 x 120 x 3 cm - 13.0"x 47.2"x 1.2"

± 12 mm  
 rectificado, rectified  
 C-1/C-3



**REMATE PELDAÑO RECTO**  
 3 x 33 cm - 1.2"x 13.0"



**ZANQUÍN RECTO IZDA/DCHA**  
 40 x 18 cm - 15.7"x 7.1"

± 15 mm



**RODAPIÉ**  
 9 x 40 cm - 3.5"x 15.7"

± 15 mm

# MARKINA / BIANCO

OUTDOOR: MARKINA BIANCO 62x120 CM [C-3] - PELDAÑO RECTO 33x120x3 CM [C-3] - TABICA 14,5x120 CM





# MARKINA / NERO

GRES EXTRUIDO · EXTRUDED KLINKER · GRÈS EXTRUDÉ · ЭКСТРУДИРОВАННЫЙ КЕРАМОГРАНИТ  
GRES PORCELÁNICO · PORCELAIN STONEWARE · GRÈS PORCELAINÉ · КЕРАМОГРАНИТ

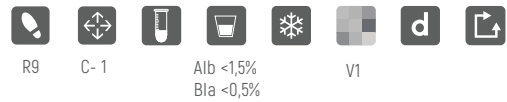

exagres  
TECHNICAL SOLUTIONS

FORMATOS · SIZES · FORMATS · ФОРМАТЫ

PIEZAS ESPECIALES · SPECIAL PIECES · PIÈCES SPÉCIALES · СПЕЦИАЛЬНЫЕ ЭЛЕМЕНТЫ

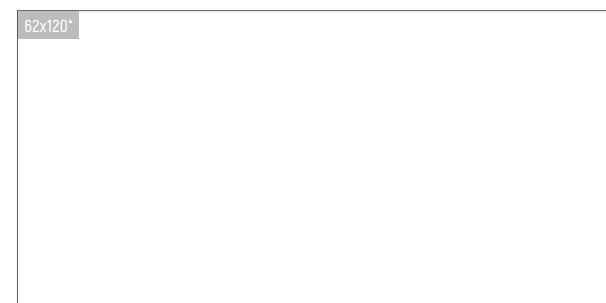

**62x120\***  
62 x 120 cm - 24.4" x 47.2"  
x 11 mm  
rectificado, rectified  
C-1

**14,5x120\***  
14,5 x 120 cm - 5.7" x 47.2"  
x 11 mm  
rectificado, rectified  
C-1

\* GRES PORCELÁNICO · PORCELAIN STONEWARE · GRÈS PORCELAINÉ · КЕРАМОГРАНИТ



**PELDAÑO RECTO 120**  
33 x 120 x 3 cm - 13.0" x 47.2" x 1.2"  
x 12 mm  
rectificado, rectified  
C-1



**REMATE PELDAÑO RECTO**  
3 x 33 cm - 1.2" x 13.0"



**ZANQUÍN RECTO IZDA/DCHA**  
40 x 18 cm - 15.7" x 7.1"  
x 15 mm



**RODAPIÉ**  
9 x 40 cm - 3.5" x 15.7"  
x 15 mm

# MARKINA / NERO

INDOOR: MARKINA NERO 62x120 CM (C-1) - PELDAÑO RECTO 33x120 CM (C-1) - TABICA 14,5x120 CM - MARKINA BIANCO 62x120 CM (C-1)





# YOHO

NATURAL WOOD ESSENCE  
IN&OUTDOOR  
STAIRS  
SWIMMINGPOOLS

COLORS:	SIZES (cm):	SIZES (inches):
NATURAL		
MAPLE	24,5x150 cm	9.8"x59.0"
OAK	14,5x120 cm	5.7"x47.2"
TECA	16,25x66,5 cm	6.4"x26.2"



INDOOR: YOHO NATURAL 24,5x150 CM [C-1]

OUTDOOR: YOHO NATURAL 16,25x66,5 CM [C-3] - BORDE SKIMMER 45x75x3 cm [C-3]

# YOHO / NATURAL

GRES EXTRUIDO · EXTRUDED KLINKER · GRÈS EXTRUDÉ · ЭКСТРУДИРОВАННЫЙ КЕРАМОГРАНИТ  
GRES PORCELÁNICO · PORCELAIN STONEWARE · GRÈS PORCELAINÉ · КЕРАМОГРАНИТ





R9 C-1 Alb <1,5% V1  
R11 C-3 CLASE C Bla <0,5%

FORMATOS · SIZES · FORMATS · ФОРМАТЫ

PIEZAS ESPECIALES · SPECIAL PIECES · PIÈCES SPÉCIALES · СПЕЦИАЛЬНЫЕ ЭЛЕМЕНТЫ



 <p><b>24,5x150*</b> 24,5 x 150 cm - 9.6"x 59.0"</p> <p>11 mm rectificado, rectified C-1/C-3</p>	 <p><b>14,5x120*</b> 14,5 x 120 cm - 5.7"x 47.2"</p> <p>10,2 mm rectificado, rectified C-1</p>	 <p><b>16,25x66,5</b> 16,25 x 66,5 cm - 6.4"x 26.2"</p> <p>10 mm C-3</p>
-------------------------------------------------------------------------------------------------------------------------------------------------------------------------------------------------	-------------------------------------------------------------------------------------------------------------------------------------------------------------------------------------------------	-----------------------------------------------------------------------------------------------------------------------------------------------------------------------

 <p><b>PELDAÑO RECTO 120</b> 33 x 120 x 3 cm - 13.0"x 47.2"x 1.2"</p> <p>12 mm rectificado, rectified C-1/C-3</p>	 <p><b>REMATE PELDAÑO RECTO</b> 3 x 33 cm - 1.2"x 13.0"</p>
 <p><b>ZANQUÍN RECTO IZDA/DCHA</b> 42,3 x 17,5 cm - 16.7"x 6.9"</p>	 <p><b>RODAPIÉ</b> 9 x 60 cm - 3.6"x 23.6"</p> <p>11 mm</p>
 <p><b>BORDE SKIMMER</b> 45 x 75 x 3 cm - 17.7"x 29.5"x 1.2"</p> <p>rectificado, rectified C-3</p>	

  
 D. Continuidad gráfica, parte trasera.  
 Graphic continuous, backside.

\* GRES PORCELÁNICO · PORCELAIN STONEWARE · GRÈS PORCELAINÉ · КЕРАМОГРАНИТ



# YOHO / NATURAL

OUTDOOR: YOHO NATURAL 24,5x150 CM (C-3) - PELDAÑO RECTO 120 33x120x3 CM (C-3) - TABICA YOHO NATURAL 14,5x120 CM





# YOHO / NATURAL

OUTDOOR: YOHO NATURAL 24,5x150 CM [C-3] - BORDE SKIMMER 45x75x3 CM [C-3]





# YOHO / MAPLE

GRES EXTRUIDO · EXTRUDED KLINKER · GRÈS EXTRUDÉ · ЭКСТРУДИРОВАННЫЙ КЕРАМОГРАНИТ  
GRES PORCELÁNICO · PORCELAIN STONEWARE · GRÈS PORCELAINÉ · КЕРАМОГРАНИТ



R9 R11 C-1 C-3 CLASE C Alb <1,5% Bla <0,5% V1

FORMATOS · SIZES · FORMATS · ФОРМАТЫ

PIEZAS ESPECIALES · SPECIAL PIECES · PIÈCES SPÉCIALES · СПЕЦИАЛЬНЫЕ ЭЛЕМЕНТЫ



<p><b>24,5x150*</b> 24,5 x 150 cm - 9.6"x 59.0"</p> <p>11 mm rectificado, rectified C-1/C-3</p>	<p><b>14,5x120*</b> 14,5 x 120 cm - 5.7"x 47.2"</p> <p>10,2 mm rectificado, rectified C-1</p>	<p><b>16,25x66,5</b> 16,25 x 66,5 cm - 6.4"x 26.2"</p> <p>10 mm C-3</p>
-------------------------------------------------------------------------------------------------------------	-----------------------------------------------------------------------------------------------------------	---------------------------------------------------------------------------------

<p><b>PELDAÑO RECTO 120</b> 33 x 120 x 3 cm - 13.0"x 47.2"x 1.2"</p> <p>12 mm rectificado, rectified C-1/C-3</p>	<p><b>REMATE PELDAÑO RECTO</b> 3 x 33 cm - 1.2"x 13.0"</p>
<p><b>ZANQUÍN RECTO IZDA/DCHA</b> 42,3 x 17,5 cm - 16.7"x 6.9"</p>	<p><b>RODAPIÉ</b> 9 x 60 cm - 3.6"x 23.6"</p> <p>11 mm</p>
<p><b>BORDE SKIMMER</b> 45 x 75 x 3 cm - 17.7"x 29.5"x 1.2"</p> <p>rectificado, rectified C-3</p>	<p>3D DESIGN D. Continuidad gráfica, parte trasera. Graphic continuous, backside.</p>

\* GRES PORCELÁNICO · PORCELAIN STONEWARE · GRÈS PORCELAINÉ · КЕРАМОГРАНИТ

# YOHO / MAPLE



INDOOR: YOHO MAPLE 24,5x150 CM [C-1] / 14,5x120 CM [C-1] - PELDAÑO RECTO 33x120x3 CM [C-1]

OUTDOOR: YOHO MAPLE 16,25x66,5 CM [C-3]





# YOHO / OAK

GRES EXTRUIDO · EXTRUDED KLINKER · GRÈS EXTRUDÉ · ЭКСТРУДИРОВАННЫЙ КЕРАМОГРАНИТ  
GRES PORCELÁNICO · PORCELAIN STONEWARE · GRÈS PORCELAINÉ · КЕРАМОГРАНИТ



R9 R11 C-1 C-3 CLASE C Alb <1,5% Bla <0,5% V1

## FORMATOS · SIZES · FORMATS · ФОРМАТЫ

24,5x150\*

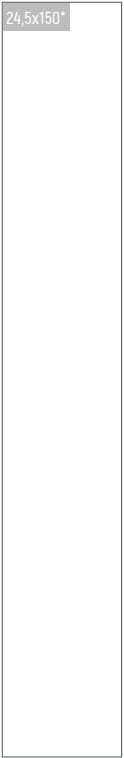

**24,5x150\***  
24,5 x 150 cm - 9.6"x 59.0"

11 mm  
rectificado, rectified  
C-1/C-3

14,5x120\*



**14,5x120\***  
14,5 x 120 cm - 5.7"x 47.2"

10,2 mm  
rectificado, rectified  
C-1

16,25x66,5



**16,25x66,5**  
16,25 x 66,5 cm - 6.4"x 26.2"

10 mm  
C-3

## PIEZAS ESPECIALES · SPECIAL PIECES · PIÈCES SPÉCIALES · СПЕЦИАЛЬНЫЕ ЭЛЕМЕНТЫ



**PELDAÑO RECTO 120**  
33 x 120 x 3 cm - 13.0"x 47.2"x 1.2"

12 mm  
rectificado, rectified  
C-1/C-3



**REMATE PELDAÑO RECTO**  
3 x 33 cm - 1.2"x 13.0"

---



**ZANQUÍN RECTO IZDA/DCHA**  
42,3 x 17,5 cm - 16.7"x 6.9"



**RODAPIÉ**  
9 x 60 cm - 3.6"x 23.6"

11 mm

---



**BORDE SKIMMER**  
45 x 75 x 3 cm - 17.7"x 29.5"x 1.2"

rectificado, rectified  
C-3



**3D DESIGN**

D. Continuidad gráfica, parte trasera.  
Graphic continuous, backside.

\* GRES PORCELÁNICO · PORCELAIN STONEWARE · GRÈS PORCELAINÉ · КЕРАМОГРАНИТ



# YOHO / OAK

OUTDOOR: YOHO OAK 24,5x150 CM (C-3) / 14,5x120 CM (C-1) - PELDAÑO RECTO 33x120x3 CM (C-3) - BORDE SKIMMER 45x75x3 CM (C-3)







GRES EXTRUIDO · EXTRUDED KLINKER · GRÈS EXTRUDÉ · ЭКСТРУДИРОВАННЫЙ КЕРАМОГРАНИТ  
 \*GRES PORCELÁNICO · PORCELAIN STONEWARE · GRÈS PORCELAINÉ · КЕРАМОГРАНИТ

- R9 R11
- C-1 C-3 CLASE C
- Alb <1,5% Bla <0,5%
- V1

FORMATOS · SIZES · FORMATS · ФОРМАТЫ

PIEZAS ESPECIALES · SPECIAL PIECES · PIÈCES SPÉCIALES · СПЕЦИАЛЬНЫЕ ЭЛЕМЕНТЫ



 <p><b>24,5x150*</b> 24,5 x 150 cm - 9.6"x 59.0"</p> <p>± 11 mm   rectificado, rectified   C-1/C-3</p>	 <p><b>14,5x120*</b> 14,5 x 120 cm - 5.7"x 47.2"</p> <p>± 10,2 mm   rectificado, rectified   C-1</p>	 <p><b>16,25x66,5</b> 16,25 x 66,5 cm - 6.4"x 26.2"</p> <p>± 10 mm   C-3</p>
-------------------------------------------------------------------------------------------------------------------------------------------------------------------------------------------------------	-------------------------------------------------------------------------------------------------------------------------------------------------------------------------------------------------------	---------------------------------------------------------------------------------------------------------------------------------------------------------------------------

 <p><b>PELDAÑO RECTO 120</b> 33 x 120 x 3 cm - 13.0"x 47.2"x 1.2"</p> <p>± 12 mm   rectificado, rectified   C-1/C-3</p>	 <p><b>REMATE PELDAÑO RECTO</b> 3 x 33 cm - 1.2"x 13.0"</p>
 <p><b>ZANQUÍN RECTO IZDA/DCHA</b> 42,3 x 17,5 cm - 16.7"x 6.9"</p>	 <p><b>RODAPIÉ</b> 9 x 60 cm - 3.6"x 23.6"</p> <p>± 11 mm</p>
 <p><b>BORDE SKIMMER</b> 45 x 75 x 3 cm - 17.7"x 29.5"x 1.2"</p> <p> rectificado, rectified   C-3</p>	

 3D DESIGN  
 D. Continuidad gráfica, parte trasera.  
 Graphic continuous, backside.

\*GRES PORCELÁNICO · PORCELAIN STONEWARE · GRÈS PORCELAINÉ · КЕРАМОГРАНИТ



# YOHO / TECA

OUTDOOR: YOHO TECA 24,5x150 CM (C-3) / 16,25x66,5 CM (C-3) - MARKINA BIANCO 60x120 CM (C-1)





WOOD



# KIOTO

ORIENTAL WOOD INSPIRED  
LARGE FORMAT  
STAIRS



COLORS:            SIZES (cm):            SIZES (inches):

NOGAL		
ROBLE	20x120 cm	7.9"x47.2"
WENGUÉ	14,5x120 cm	5.7"x47.2"

KIOTO NOGAL 20x120 CM [C-1] - TABICA 14,5x120 CM [C-1] - PELDAÑO RECTO 33x120x3 CM [C-1] - RODAPIÉ 9x60 CM

# KIOTO /

GRES EXTRUIDO · EXTRUDED KLINKER · GRÈS EXTRUDÉ · ЭКСТРУДИРОВАННЫЙ КЕРАМОГРАНИТ  
 \*GRES PORCELÁNICO · PORCELAIN STONEWARE · GRÈS PORCELAINÉ · КЕРАМОГРАНИТ

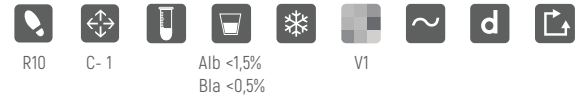

NOGAL

ROBLE

WENGUÉ



FORMATOS · SIZES · FORMATS · ФОРМАТЫ



**20x120\***  
 20 x 120 cm - 7.9"x 47.2"  
 ✂ 10,2 mm  
 📏 rectificado, rectified  
 🧱 C-1



**14,5x120\***  
 14,5 x 120 cm - 5.7"x 47.2"  
 ✂ 10,2 mm  
 📏 rectificado, rectified  
 🧱 C-1

# NOGAL / ROBLE / WENGUÉ



PIEZAS ESPECIALES · SPECIAL PIECES · PIÈCES SPÉCIALES · СПЕЦИАЛЬНЫЕ ЭЛЕМЕНТЫ



**PELDAÑO FIORENTINO 120**  
 33 x 120 x 3 cm - 13.0"x 47.2" x 1.2"  
 ✂ 12 mm  
 📏 rectificado, rectified  
 🧱 C-1



**PELDAÑO RECTO 120**  
 33 x 120 x 3 cm - 13.0"x 47.2" x 1.2"  
 ✂ 12 mm  
 📏 rectificado, rectified  
 🧱 C-1



**REMATE PELDAÑO FIORENTINO IZDA/DCHA**  
 3 x 33 cm - 1.2" x 13.0"



**REMATE PELDAÑO RECTO**  
 3 x 33 cm - 1.2" x 13.0"



**ZANQUÍN FIORENTINO IZDA/DCHA**  
 39,5 x 17,5 cm - 15.6" x 6.9"



**ZANQUÍN RECTO IZDA/DCHA**  
 42,3 x 17,5 cm - 16.7" x 6.9"



**RODAPIÉ**  
 9 x 60 cm - 3.6" x 23.6"  
 ✂ 11 mm

\*GRES PORCELÁNICO · PORCELAIN STONEWARE · GRÈS PORCELAINÉ · КЕРАМОГРАНИТ



# KIOTO / NOGAL

INDOOR: KIOTO NOGAL 20x120 CM (C-1) - TABICA 14,5x120 CM (C-1) - PELDAÑO RECTO 33x120x3 CM - REMATE PELDAÑO RECTO 3x33 CM - ZANQUÍN RECTO 42,3x17,5 CM



# / ROBLE

INDOOR: KIOTO ROBLE 20x120 CM (C-1) - TABICA 14,5x120 CM (C-1) - PELDAÑO FIORENTINO 33x120x3 CM - REMATE PELDAÑO FIORENTINO 3x33 CM - ZANQUÍN FIORENTINO DCHA 39,5x17,5 CM



WOOD

# NATURA

ANTISLIP WOOD TEXTURE  
OUTDOOR  
STAIRS  
SWIMMINGPOOLS

COLORS:                      SIZES (cm):                      SIZES (inches):

KENIA		
ETNA		
CRETA	16,25x66,5 cm	6.4"x26.2"

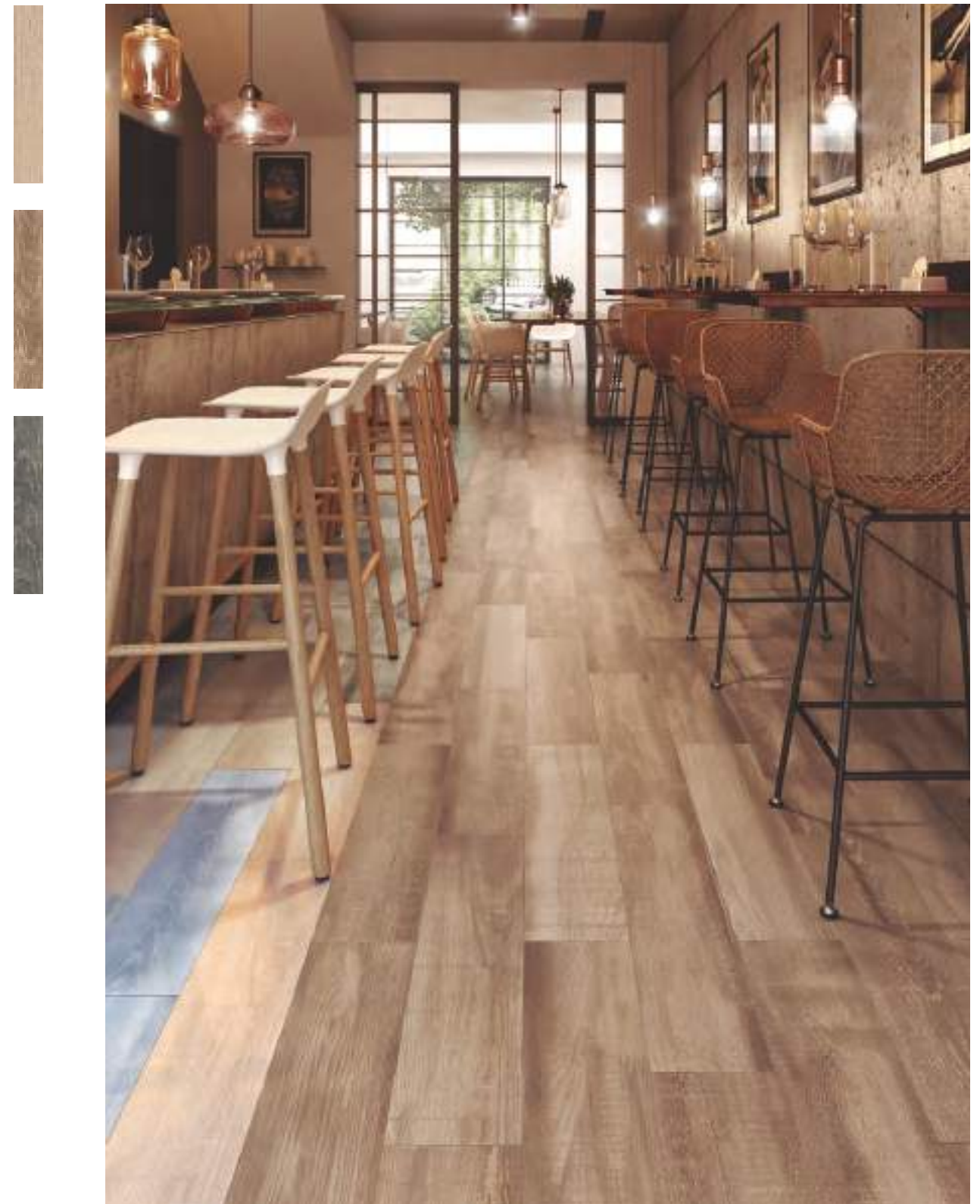

NATURA ETNA 16,25x66,5 CM - CHROMATIC 16,25x66,5 CM



# NATURA /

GRES EXTRUIDO · EXTRUDED KLINKER · GRÈS EXTRUDÉ · ЭКСТРУДИРОВАННЫЙ КЕРАМОГРАНИТ



KENIA

ETNA

CRETA



FORMATOS · SIZES · FORMATS · ФОРМАТЫ

## KENIA / ETNA / CRETA



DECORADOS · DECORS · DÉCORÉ · УКРАШЕН



**NOTE KENIA\***  
16,25 x 66,5 cm - 6.4"x 26.2"  
± 10 mm \*1 set 3 piezas - 3 pieces pack



**CHROMATIC\***  
16,25 x 66,5 cm - 6.4"x 26.2"  
± 10 mm \*1 set 6 piezas - 6 pieces pack

PIEZAS ESPECIALES · SPECIAL PIECES · PIÈCES SPÉCIALES · СПЕЦИАЛЬНЫЕ ЭЛЕМЕНТЫ

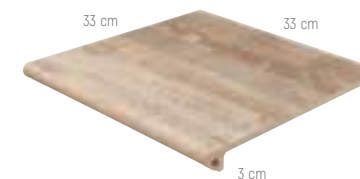

**PELDAÑO FIORENTINO**  
33 x 33 x 3 cm - 13.0"x 13.0" x 1.2"  
± 12 mm

C-3



**CARTABÓN FIORENTINO IZDA/DCHA.**  
33 x 33 x 3 cm - 13.0"x 13.0" x 1.2"

± 14 mm  
rectificado, rectified  
C-3



**ZANQUÍN FIORENTINO IZDA/DCHA**  
39,5 x 17,5 cm - 15.6"x 6.9"



**RODAPIÉ**  
9 x 33 cm - 3.6"x 13.0"  
± 11 mm



**BORDE PISCINA**  
28 x 66,5 cm - 11.0"x 26.2"  
± 10 mm

C-3



**ÁNGULO EXTERIOR PISCINA**  
28 x 28 cm - 11.0"x 11.0"  
rectificado, rectified  
C-3

C-3



**ÁNGULO INTERIOR PISCINA**  
33 x 33 cm - 13.0"x 13.0"  
rectificado, rectified  
C-3

C-3



**16,25x66,5**  
16,25 x 66,5 cm - 6.4"x 26.2"  
± 10 mm

C-3



# NATURA / KENIA

INDOOR / OUTDOOR: NATURA KENIA 16,25x66,5 CM - PELDAÑO FIORENTINO 33x33x3 CM



# / CRETA

OUTDOOR: NATURA CRETA 16,25x66,5 CM - BORDE PISCINA 28x66,5 CM - ÁNGULO INTERIOR PISCINA 33x33 CM

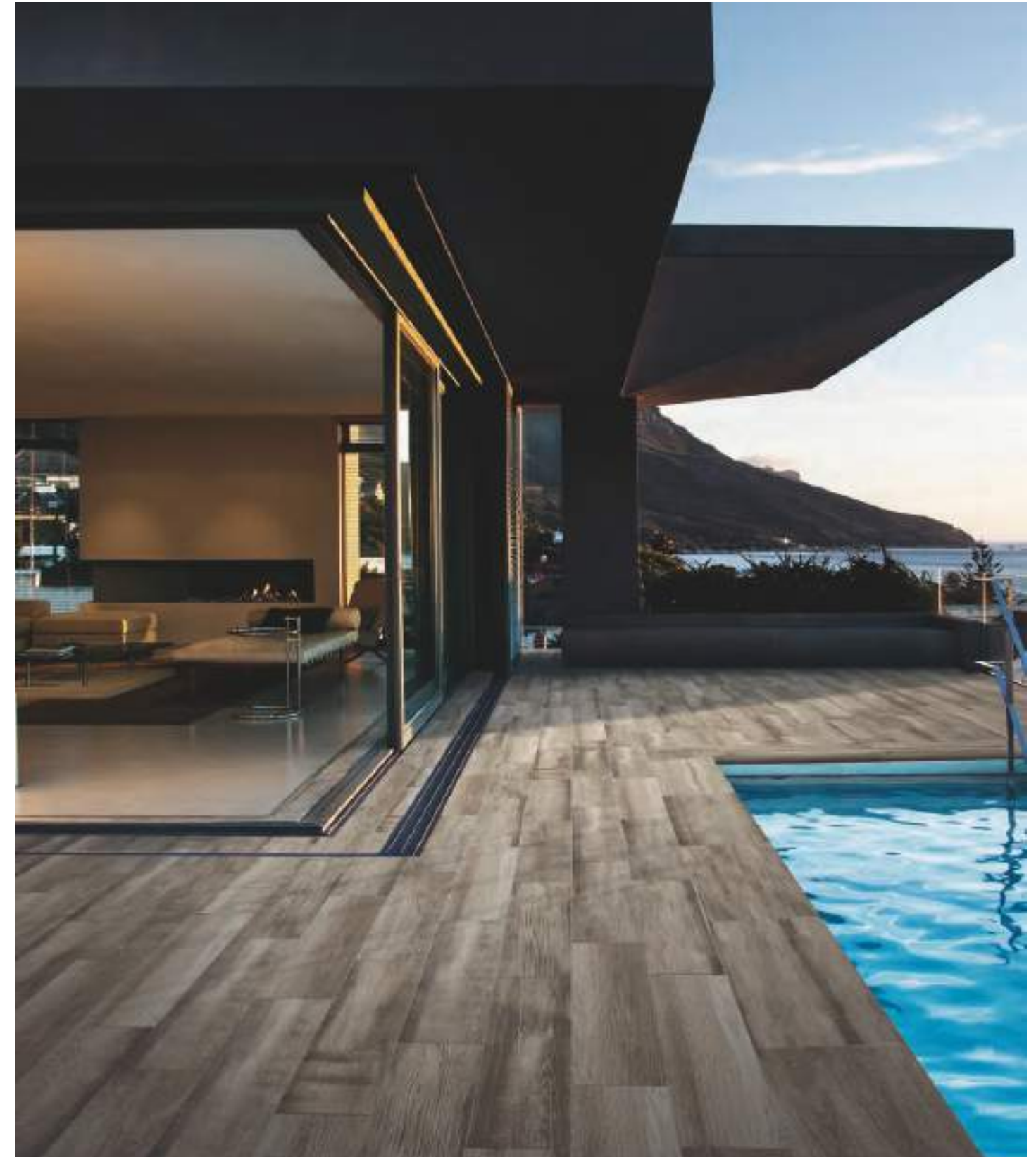



# ÓPERA

CONCRETE & INDUSTRIAL TREND  
IN&OUTDOOR  
LARGE FORMATS  
STAIRS  
SWIMMINGPOOLS

COLORS:	SIZES (cm):	SIZES (inches):
LIGHT	120x120 cm	47.2"x47.2"
IVORY	60x120 cm	23.7"x47.2"
SILVER	14,5x120 cm	5.7"x47.2"
IRON	33x66,5 cm	13.0"x26.2"



ÓPERA IRON 120x120 CM [C-3] - ÓPERA IRON 33x66,5 CM [C-1] / 14,5x120 CM [C-1] - PELDAÑO RECTO 33x120x3 CM [C-3] -BORDE DESBORDANTE 28x66,5 CM [C-3] - ÁNG. DESBORDANTE 31x31 CM [C-3] - REJILLA 24,5x24,5 CM - ANG. REJILLA 24,5x33 CM - MEDIA CAÑA 33x4 CM

# ÓPERA / IVORY



GRES EXTRUIDO · EXTRUDED KLINKER · GRÈS EXTRUDÉ · ЭКСТРУДИРОВАННЫЙ КЕРАМОГРАНИТ  
GRES PORCELÁNICO · PORCELAIN STONEWARE · GRÈS PORCELAINÉ · КЕРАМОГРАНИТ



R9 C-1 Alb <1,5% V3  
R12 C-3 CLASE C Bla <0,5%

## FORMATOS · SIZES · FORMATS · ФОРМАТЫ

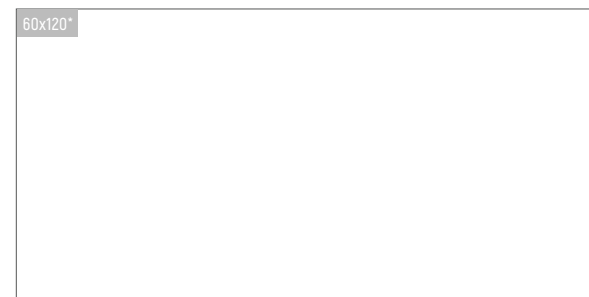
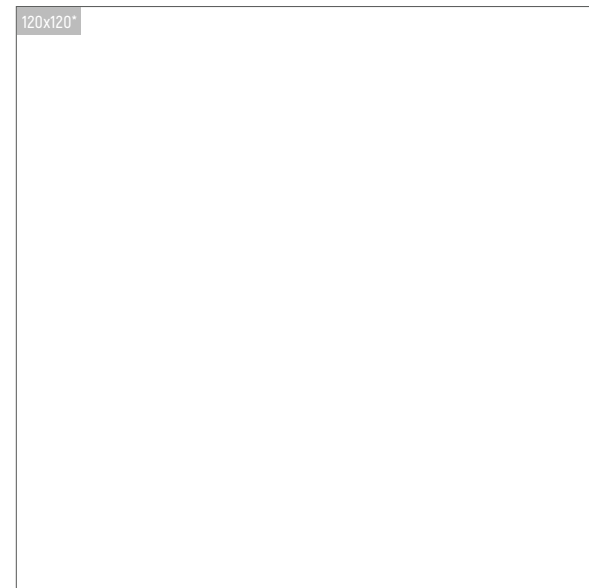

<p><b>120x120*</b> 120 x 120 cm - 47.2"x 47.2"</p> <p>12 mm rectificado. rectified C-1/C-3</p>	<p><b>60x120*</b> 60 x 120 cm - 23.7"x 47.2"</p> <p>10 mm rectificado. rectified C-1/C-3</p>	<p><b>14,5x120*</b> 14,5 x 120 cm - 5.7"x 47.2"</p> <p>10 mm rectificado. rectified C-1</p>	<p><b>33x66,5</b> 33 x 66,5 cm - 13.0"x 26.2"</p> <p>10 mm rectificado. rectified C-1/C-3</p>
----------------------------------------------------------------------------------------------------------------	--------------------------------------------------------------------------------------------------------------	-------------------------------------------------------------------------------------------------------------	---------------------------------------------------------------------------------------------------------------

## PIEZAS ESPECIALES · SPECIAL PIECES · PIÈCES SPÉCIALES · СПЕЦИАЛЬНЫЕ ЭЛЕМЕНТЫ



**PELDAÑO RECTO 120**  
33 x 120 x 3 cm - 13.0"x 47.2"x 1.2"

12 mm  
rectificado. rectified  
C-1/C-3



**REMATE PELDAÑO RECTO**  
3 x 33 cm - 1.2"x 13.0"



**RODAPIÉ**  
9 x 60 cm - 3.6"x 23.6"

11 mm



**ZANQUÍN RECTO IZDA/DCHA**  
42,3 x 17,5 cm - 16.7"x 6.9"



**BORDE SKIMMER**  
45 x 75 x 3 cm - 17.7"x 29.5"x 1.2"

rectificado. rectified  
C-3



D. Continuidad gráfica, parte trasera.  
Graphic continuous, backside.



**BORDE DESBORDANTE**  
28 x 66,5 cm - 11.0"x 26.2"

rectificado. rectified  
C-3



**ÁNGULO DESBORDANTE**  
31 x 31 cm - 12.2"x 12.2"

rectificado. rectified  
C-3



**REJILLA**  
24,5 x 24,5 cm - 9.6"x 9.6"

rectificado. rectified  
C-3



**ÁNGULO REJILLA DERECHA\***  
24,5 x 33 cm - 9.6"x 13.0"

rectificado. rectified  
C-3



**ÁNGULO REJILLA IZQUIERDA\***  
24,5 x 33 cm - 9.6"x 13.0"

rectificado. rectified  
C-3

\*set de 2 piezas [izda./dcha.] \*two pieces set [left/right]



**MEDIA CAÑA**  
33 x 4 cm - 13.0"x 1.6"

r-3 cm



**UÑA**  
4 x 4 cm - 1.6"x 1.6"



**ARISTA**  
33 x 3 cm - 13.0"x 1.2"

r-3 cm



**UÑA ARISTA**  
3 x 3 cm - 1.2"x 1.2"



# ÓPERA / IVORY

INDOOR: ÓPERA IVORY 120x120 CM [C-1]

OUTDOOR: ÓPERA IVORY 60x120 CM [C-3] - ÓPERA IVORY 120x120 CM [C-3] - BORDE DESBORDANTE 28x66,5 CM [C-3] -

REJILLA 24,5x24,5 CM [C-3] - ÁNGULO DESBORDANTE 31x31 CM - ÁNGULO REJILLA IZDA./DCHA. 24,5x33 CM [C-3] - MEDIA CAÑA 33x4 CM - ÓPERA IVORY 33x66,5 CM [C-1]





# ÓPERA / IVORY

INDOOR: ÓPERA IVORY 120x120 CM (C-1) - 60x120 CM (C-1) - PELDAÑO RECTO 120 33x120x3 CM - TABICA ÓPERA IVORY 14,5x120 CM





# ÓPERA / LIGHT



GRES EXTRUIDO · EXTRUDED KLINKER · GRÈS EXTRUDÉ · ЭКСТРУДИРОВАННЫЙ КЕРАМОГРАНИТ  
 GRES PORCELÁNICO · PORCELAIN STONEWARE · GRÈS PORCELAINÉ · КЕРАМОГРАНИТ

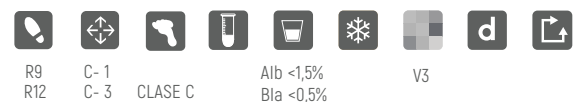

R9 C-1 Alb <1,5% V3  
 R12 C-3 CLASE C Bla <0,5%

## FORMATOS · SIZES · FORMATS · ФОРМАТЫ

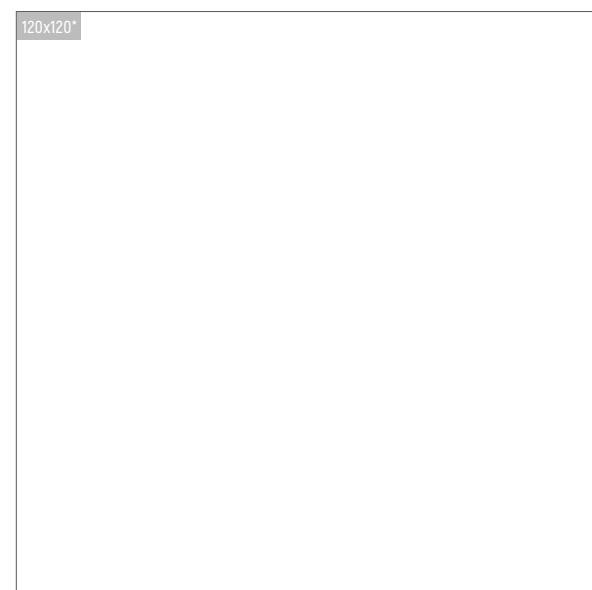

<b>120x120*</b> 120 x 120 cm - 47.2"x 47.2" 10 mm rectificado, rectified C-1/C-3	<b>60x120*</b> 60 x 120 cm - 23.7"x 47.2" 10 mm rectificado, rectified C-1/C-3	<b>14,5x120*</b> 14,5 x 120 cm - 5.7"x 47.2" 10 mm rectificado, rectified C-1	<b>33x66,5</b> 33 x 66,5 cm - 13.0"x 26.2" 10 mm rectificado, rectified C-1/C-3
----------------------------------------------------------------------------------------------	--------------------------------------------------------------------------------------------	-------------------------------------------------------------------------------------------	---------------------------------------------------------------------------------------------

## PIEZAS ESPECIALES · SPECIAL PIECES · PIÈCES SPÉCIALES · СПЕЦИАЛЬНЫЕ ЭЛЕМЕНТЫ



**PELDAÑO RECTO 120**  
 33 x 120 x 3 cm - 13.0"x 47.2"x 1.2"  
 12 mm  
 rectificado, rectified  
 C-1/C-3



**REMATE PELDAÑO RECTO**  
 3 x 33 cm - 1.2"x 13.0"



**RODAPIÉ**  
 9 x 60 cm - 3.6"x 23.6"  
 11 mm



**ZANQUÍN RECTO IZDA/DCHA**  
 42,3 x 17,5 cm - 16.7"x 6.9"



**BORDE SKIMMER**  
 45 x 75 x 3 cm - 17.7"x 29.5"x 1.2"  
 rectificado, rectified  
 C-3



D. Continuidad gráfica, parte trasera.  
 Graphic continuous, backside.



**BORDE DESBORDANTE**  
 28 x 66,5 cm - 11.0"x 26.2"  
 rectificado, rectified  
 C-3



**ÁNGULO DESBORDANTE**  
 31 x 31 cm - 12.2"x 12.2"  
 rectificado, rectified  
 C-3



**REJILLA**  
 24,5 x 24,5 cm - 9.6"x 9.6"  
 rectificado, rectified  
 C-3



**ÁNGULO REJILLA DERECHA\***  
 24,5 x 33 cm - 9.6"x 13.0"  
 rectificado, rectified  
 C-3



**ÁNGULO REJILLA IZQUIERDA\***  
 24,5 x 33 cm - 9.6"x 13.0"  
 rectificado, rectified  
 C-3

\*set de 2 piezas [izda./dcha.] \*two pieces set [left/right]



**MEDIA CAÑA**  
 33 x 4 cm - 13.0"x 1.6"  
 r-3 cm



**UÑA**  
 4 x 4 cm - 1.6"x 1.6"



**ARISTA**  
 33 x 3 cm - 13.0"x 1.2"  
 r-3 cm



**UÑA ARISTA**  
 3 x 3 cm - 1.2"x 1.2"

\* GRES PORCELÁNICO · PORCELAIN STONEWARE · GRÈS PORCELAINÉ · КЕРАМОГРАНИТ



# ÓPERA / LIGHT

exagres

TECHNICAL SOLUTIONS

OUTDOOR: ÓPERA LIGHT 60x120 CM [C-3] - PELDAÑO RECTO 33x120x3 CM [C-3] - TABICA 14,5x120 CM [C-1] - BORDE SKIMMER 45x75x3 CM [C-3]

INDOOR: ÓPERA LIGHT 60x120 CM [C-1]





# ÓPERA / LIGHT

INDOOR: ÓPERA LIGHT 120x120 CM [C-1] - PELDAÑO RECTO 33x120x3 CM [C-1] - TABICA ÓPERA LIGHT 14,5x120 CM



# ÓPERA / SILVER



GRES EXTRUIDO · EXTRUDED KLINKER · GRÈS EXTRUDÉ · ЭКСТРУДИРОВАННЫЙ КЕРАМОГРАНИТ  
GRES PORCELÁNICO · PORCELAIN STONEWARE · GRÈS PORCELAINÉ · КЕРАМОГРАНИТ



R9 C-1 CLASE C Alb <1.5% V3  
R12 C-3

## FORMATOS · SIZES · FORMATS · ФОРМАТЫ

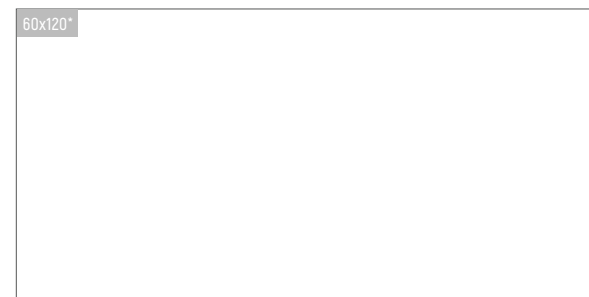
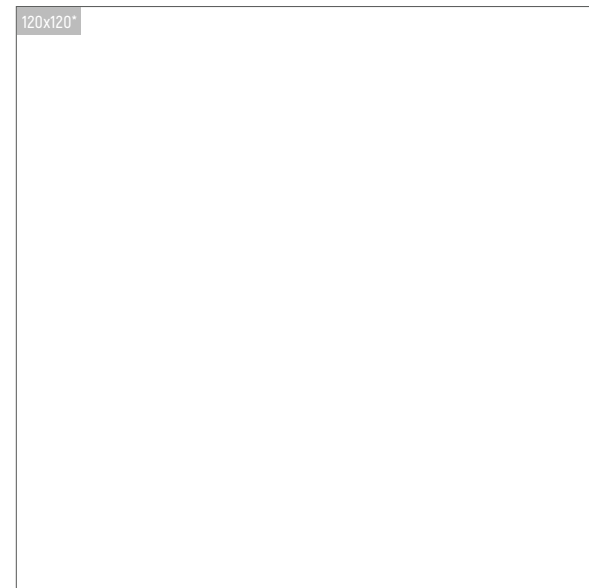

<b>120x120*</b> 120 x 120 cm - 47.2"x 47.2" 10 mm rectificado, rectified C-1/C-3	<b>60x120*</b> 60 x 120 cm - 23.7"x 47.2" 10 mm rectificado, rectified C-1/C-3	<b>14,5x120*</b> 14,5 x 120 cm - 5.7"x 47.2" 10 mm rectificado, rectified C-1	<b>33x66,5</b> 33 x 66,5 cm - 13.0"x 26.2" 10 mm rectificado, rectified C-1/C-3
----------------------------------------------------------------------------------------------	--------------------------------------------------------------------------------------------	-------------------------------------------------------------------------------------------	---------------------------------------------------------------------------------------------

## PIEZAS ESPECIALES · SPECIAL PIECES · PIÈCES SPÉCIALES · СПЕЦИАЛЬНЫЕ ЭЛЕМЕНТЫ



**PELDAÑO RECTO 120**  
33 x 120 x 3 cm - 13.0"x 47.2"x 1.2"  
 12 mm  
 rectificado, rectified  
 C-1/C-3



**REMATE PELDAÑO RECTO**  
3 x 33 cm - 1.2"x 13.0"

**RODAPIÉ**  
9 x 60 cm - 3.6"x 23.6"  
 11 mm



**ZANQUÍN RECTO IZDA/DCHA**  
42,3 x 17,5 cm - 16.7"x 6.9"



**BORDE SKIMMER**  
45 x 75 x 3 cm - 17.7"x 29.5"x 1.2"  
 rectificado, rectified  
 C-3



D. Continuidad gráfica, parte trasera.  
Graphic continuous, backside.



**BORDE DESBORDANTE**  
28 x 66,5 cm - 11.0"x 26.2"  
 rectificado, rectified  
 C-3



**ÁNGULO DESBORDANTE**  
31 x 31 cm - 12.2"x 12.2"  
 rectificado, rectified  
 C-3



**REJILLA**  
24,5 x 24,5 cm - 9.6"x 9.6"  
 rectificado, rectified  
 C-3



**ÁNGULO REJILLA DERECHA\***  
24,5 x 33 cm - 9.6"x 13.0"  
 rectificado, rectified  
 C-3



**ÁNGULO REJILLA IZQUIERDA\***  
24,5 x 33 cm - 9.6"x 13.0"  
 rectificado, rectified  
 C-3

\*set de 2 piezas [izda./dcha.] \*two pieces set [left/right]



**MEDIA CAÑA**  
33 x 4 cm - 13.0"x 1.6"  
 r-3 cm



**UÑA**  
4 x 4 cm - 1.6"x 1.6"



**ARISTA**  
33 x 3 cm - 13.0"x 1.2"  
 r-3 cm



**UÑA ARISTA**  
3 x 3 cm - 1.2"x 1.2"

\* GRES PORCELÁNICO · PORCELAIN STONEWARE · GRÈS PORCELAINÉ · КЕРАМОГРАНИТ



# ÓPERA / SILVER



OUTDOOR: ÓPERA SILVER 60x120 CM [C-3] / 120x120 CM [C-3] - BORDE SKIMMER 45x75x3 CM [C-3] - ÓPERA SILVER 33x66,5 CM [C-1] - MEDIA CAÑA 33x4 CM - UÑA 4x4 CM

INDOOR: ÓPERA SILVER 60x120 CM [C-1]





# ÓPERA / IRON



GRES EXTRUIDO · EXTRUDED KLINKER · GRÈS EXTRUDÉ · ЭКСТРУДИРОВАННЫЙ КЕРАМОГРАНИТ  
GRES PORCELÁNICO · PORCELAIN STONEWARE · GRÈS PORCELAINÉ · КЕРАМОГРАНИТ



R9 C-1 Alb <1,5% V3  
R12 C-3 CLASE C Bla <0,5%

## FORMATOS · SIZES · FORMATS · ФОРМАТЫ

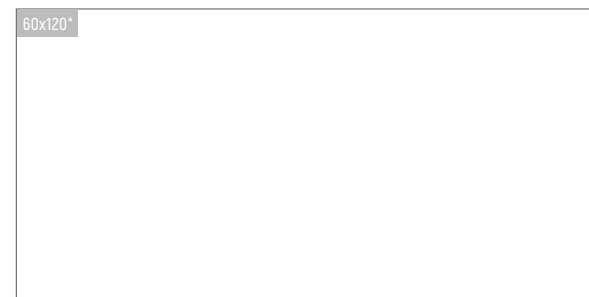
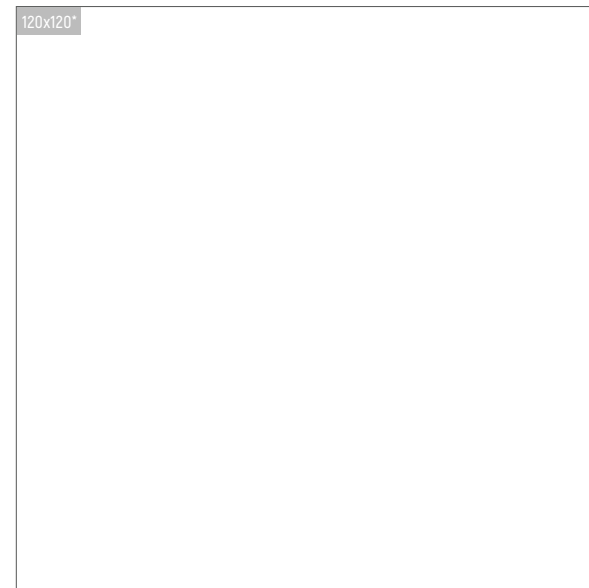

<b>120x120*</b> 120 x 120 cm - 47.2"x 47.2" 10 mm rectificado, rectified C-1/C-3	<b>60x120*</b> 60 x 120 cm - 23.7"x 47.2" 10 mm rectificado, rectified C-1/C-3	<b>14,5x120*</b> 14,5 x 120 cm - 5.7"x 47.2" 10 mm rectificado, rectified C-1	<b>33x66,5</b> 33 x 66,5 cm - 13.0"x 26.2" 10 mm rectificado, rectified C-1/C-3
----------------------------------------------------------------------------------------------	--------------------------------------------------------------------------------------------	-------------------------------------------------------------------------------------------	---------------------------------------------------------------------------------------------

## PIEZAS ESPECIALES · SPECIAL PIECES · PIÈCES SPÉCIALES · СПЕЦИАЛЬНЫЕ ЭЛЕМЕНТЫ



**PELDAÑO RECTO 120**  
33 x 120 x 3 cm - 13.0"x 47.2"x 1.2"  
 12 mm  
 rectificado, rectified  
 C-1/C-3



**REMATE PELDAÑO RECTO**  
3 x 33 cm - 1.2"x 13.0"



**RODAPIÉ**  
9 x 60 cm - 3.6"x 23.6"  
 11 mm



**ZANQUÍN RECTO IZDA/DCHA**  
42,3 x 17,5 cm - 16.7"x 6.9"



**BORDE SKIMMER**  
45 x 75 x 3 cm - 17.7"x 29.5"x 1.2"  
 rectificado, rectified  
 C-3



D. Continuidad gráfica, parte trasera.  
Graphic continuous, backside.



**BORDE DESBORDANTE**  
28 x 66,5 cm - 11.0"x 26.2"  
 rectificado, rectified  
 C-3



**ÁNGULO DESBORDANTE**  
31 x 31 cm - 12.2"x 12.2"  
 rectificado, rectified  
 C-3



**REJILLA**  
24,5 x 24,5 cm - 9.6"x 9.6"  
 rectificado, rectified  
 C-3



**ÁNGULO REJILLA DERECHA\***  
24,5 x 33 cm - 9.6"x 13.0"  
 rectificado, rectified  
 C-3



**ÁNGULO REJILLA IZQUIERDA\***  
24,5 x 33 cm - 9.6"x 13.0"  
 rectificado, rectified  
 C-3

\*set de 2 piezas [izda./dcha.] \*two pieces set [left/right]



**MEDIA CAÑA**  
33 x 4 cm - 13.0"x 1.6"  
 r-3 cm



**UÑA**  
4 x 4 cm - 1.6"x 1.6"



**ARISTA**  
33 x 3 cm - 13.0"x 1.2"  
 r-3 cm



**UÑA ARISTA**  
3 x 3 cm - 1.2"x 1.2"

\* GRES PORCELÁNICO · PORCELAIN STONEWARE · GRÈS PORCELAINÉ · КЕРАМОГРАНИТ



# ÓPERA / IRON

exagres

TECHNICAL SOLUTIONS

OUTDOOR: ÓPERA IRON 120x120 CM [C-3] - PELDAÑO RECTO 33x120x3 CM [C-3] - TABICA 14,5x120 CM - BORDE DESBORDANTE 28x66,5 CM [C-3] - REJILLA 24,5x24,5 CM [C-3]

ÁNG. REJILLA IZDA./DCHA. 24,5x33 CM [C-3] - ÁNG. DESBORDANTE 31x31 CM [C-3] - MEDIA CAÑA 33x4 CM - UÑA 4x4 CM - ÓPERA IRON 33x66,5 CM [C-1] INDOOR: ÓPERA IRON 60x120 CM [C-1]





# ÓPERA / IRON



INDOOR: ÓPERA IRON 60x120 CM [C-1]

OUTDOOR: ÓPERA IRON 120x120 CM [C-3] - BORDE SKIMMER 45x75x3 CM [C-3]





# ÓPERA / IRON

INDOOR: ÓPERA IRON 60x120 CM (C-1) - YOHO OAK 24,5x150 CM (C-1)



URBAN

# MEDITERRÁNEO

CEMENT SLATE DESIGN  
IN&OUTDOOR  
STAIRS



COLORS:      SIZES (cm):      SIZES (inches):

ARENA	33x66,5 cm	13.0"x26.2"
GRAFITO	33x33 cm	13.0"x13.0"

PELDAÑO RECTO GRAFITO 33x33x3 CM (C-1) - ZANQUÍN RECTO IZDA. GRAFITO 42,3x17,5 CM



# MEDITERRÁNEO /

GRES EXTRUIDO · EXTRUDED KLINKER · GRÈS EXTRUDÉ · ЭКСТРУДИРОВАННЫЙ КЕРАМОГРАНИТ

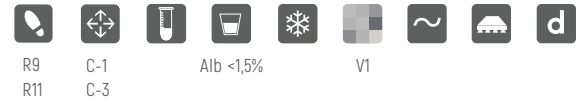

ARENA

GRAFITO



FORMATOS · SIZES · FORMATS · ФОРМАТЫ

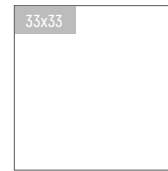

**33x66,5**  
33 x 66,5 cm - 13.0"x 26.2"  
x 10 mm  
C-1 / C-3

**33x33**  
33 x 33 cm - 13.0"x 13.0"  
x 10 mm  
C-1 / C-3

# ARENA / GRAFITO



PIEZAS ESPECIALES · SPECIAL PIECES · PIÈCES SPÉCIALES · СПЕЦИАЛЬНЫЕ ЭЛЕМЕНТЫ

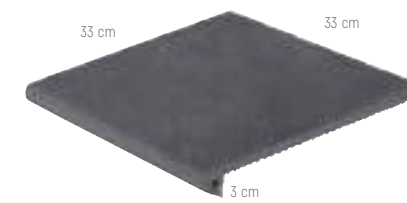

**PELDAÑO FIORENTINO**  
33 x 33 x 3 cm - 13.0"x 13.0"x1.2"  
x 12 mm  
C-1/C-3

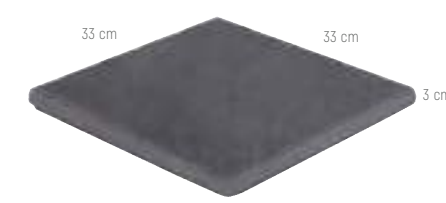

**CARTABÓN FIORENTINO**  
33 x 33 x 3 cm - 13.0"x 13.0"x1.2"  
x 14 mm  
C-1/C-3  
rectificado, rectified

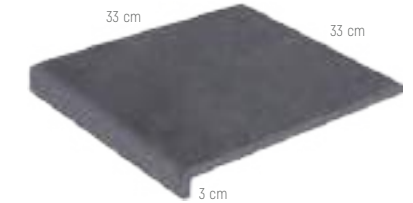

**PELDAÑO RECTO**  
33 x 33 x 3 cm - 13.0"x 13.0"x1.2"  
x 12 mm  
C-1/C-3



**ZANQUIN FIORENTINO IZDA./DCHA.**  
39,5 x 17,5 cm - 15.6"x 6.9"



**ZANQUIN RECTO IZDA./DCHA.**  
42,3 x 17,5 cm - 16.7"x 6.9"



**RODAPIÉ**  
9 x 33 cm - 3.6"x 13.0"  
x 7,5 mm



**VIERTEAGUAS**  
12 x 33 x 3 cm - 3.6"x 13.0"x1.2"  
x 12 mm



**PASAMANOS 12"**  
12,5 x 66,5 x 4 cm - 4.9"x 26.2"x1.6"



**PASAMANOS 15"**  
15,5 x 66,5 x 4 cm - 6.1"x 26.2"x1.6"

\*medidas interiores, inner measures.



# MEDITERRÁNEO / ARENA

exagres

TECHNICAL SOLUTIONS

OUTDOOR: MEDITERRÁNEO ARENA 33x66,5 CM (C-3) - PELDAÑO RECTO 33x33x3 CM (C-3)





STONE

# MILÁN

INSPIRED BY GEOLOGY  
IN&OUTDOOR  
STAIRS  
SWIMMINGPOOLS

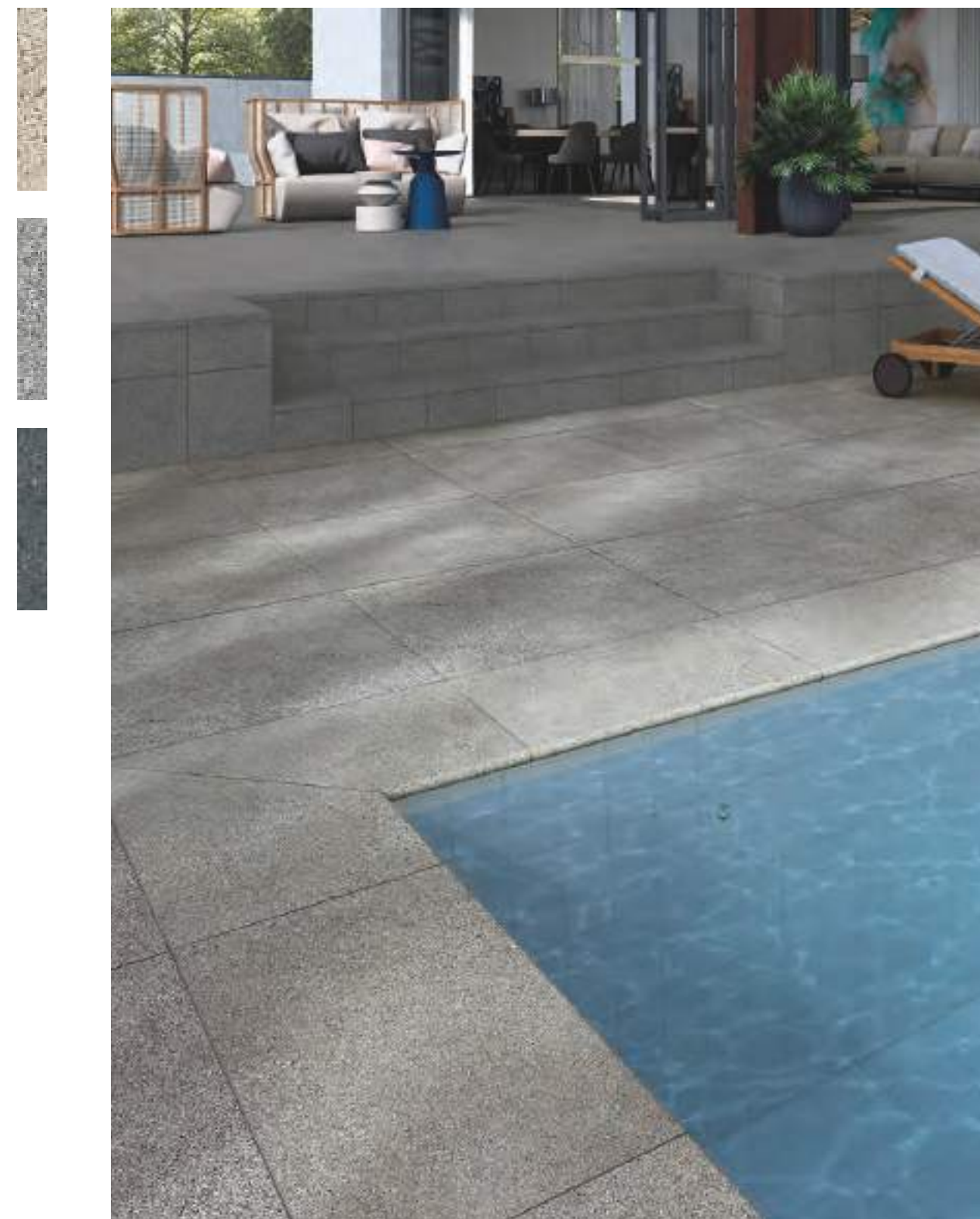

COLORS:	SIZES (cm):	SIZES (inches):
ARENA	75x75 cm	29.5"x29.5"
GRIS	14,5x120 cm	5.7"x47.2"
MARENGO	33x33 cm	13.0"x13.0"

MILÁN GRIS 75x75 CM [C-3] - MILÁN MARENGO 33x33 CM [C-3] - BORDE SKIMMER MILÁN GRIS 45x75x3 CM [C-3] - MILÁN MARENGO PELDAÑO RECTO 33x33x3 CM [C-3]

# MILÁN / ARENA

exagres  
TECHNICAL SOLUTIONS

GRES EXTRUIDO · EXTRUDED KLINKER · GRÈS EXTRUDÉ · ЭКСТРУДИРОВАННЫЙ КЕРАМОГРАНИТ  
GRES PORCELÁNICO · PORCELAIN STONEWARE · GRÈS PORCELAINÉ · КЕРАМОГРАНИТ



R9 C-1 Alb <1,5% V1  
R12 C-3 CLASE C Bla <0,5%

FORMATOS · SIZES · FORMATS · ФОРМАТЫ

PIEZAS ESPECIALES · SPECIAL PIECES · PIÈCES SPÉCIALES · СПЕЦИАЛЬНЫЕ ЭЛЕМЕНТЫ

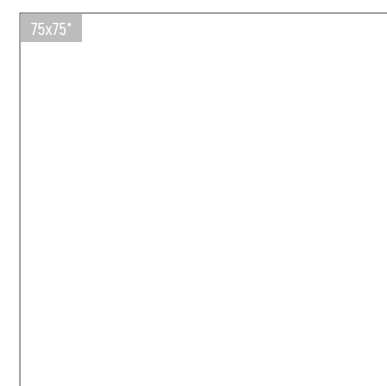
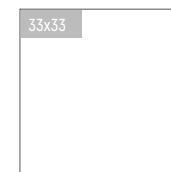

<b>75x75*</b> 75 x 75 cm - 29.5" x 29.5"	<b>14,5x120*</b> 14,5 x 120 cm - 5.7" x 47.2"	<b>33x33</b> 33 x 33 cm - 13.0" x 13.0"
11 mm rectificado, rectified C-1/C-3	10,2 mm rectificado, rectified C-1	10 mm C-3



**PELDAÑO RECTO 120**  
33 x 120 x 3 cm - 13.0" x 47.2" x 1.2"  
12 mm  
rectificado, rectified  
C-1/ C-3



**PELDAÑO RECTO**  
33 x 33 x 3 cm - 13.0" x 13.0" x 1.2"  
12 mm  
rectificado, rectified  
C-3



**REMATE PELDAÑO RECTO**  
3 x 33 cm - 1.2" x 13.0"



**RODAPIÉ**  
9 x 60 cm - 3.6" x 23.6"  
11 mm



**ZANQUÍN RECTO IZDA/DCHA**  
42,3 x 17,5 cm - 16.7" x 6.9"



**BORDE SKIMMER**  
45 x 75 x 3 cm - 17.7" x 29.5" x 1.2"  
rectificado, rectified  
C-3

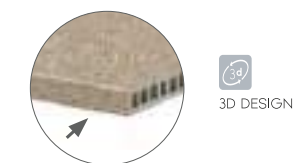

D. Continuidad gráfica, parte trasera.  
Graphic continuous, backside.

\* GRES PORCELÁNICO · PORCELAIN STONEWARE · GRÈS PORCELAINÉ · КЕРАМОГРАНИТ



# MILÁN / ARENA

INDOOR: MILÁN ARENA 75x75 CM [C-1]- PELDAÑO RECTO 120 33x120x3 CM [C-1] - TABICA MILÁN ARENA 14,5x120 CM





# MILÁN / ARENA

OUTDOOR: MILÁN ARENA / GRIS 33x33 CM (C-3) - PELDAÑO RECTO MILÁN ARENA 33x120x3 CM (C-3) - TABICA MILÁN ARENA 14,5x120 CM

INDOOR: MILÁN ARENA 75x75 CM (C-1) - PELDAÑO RECTO 33x120 CM (C-1)

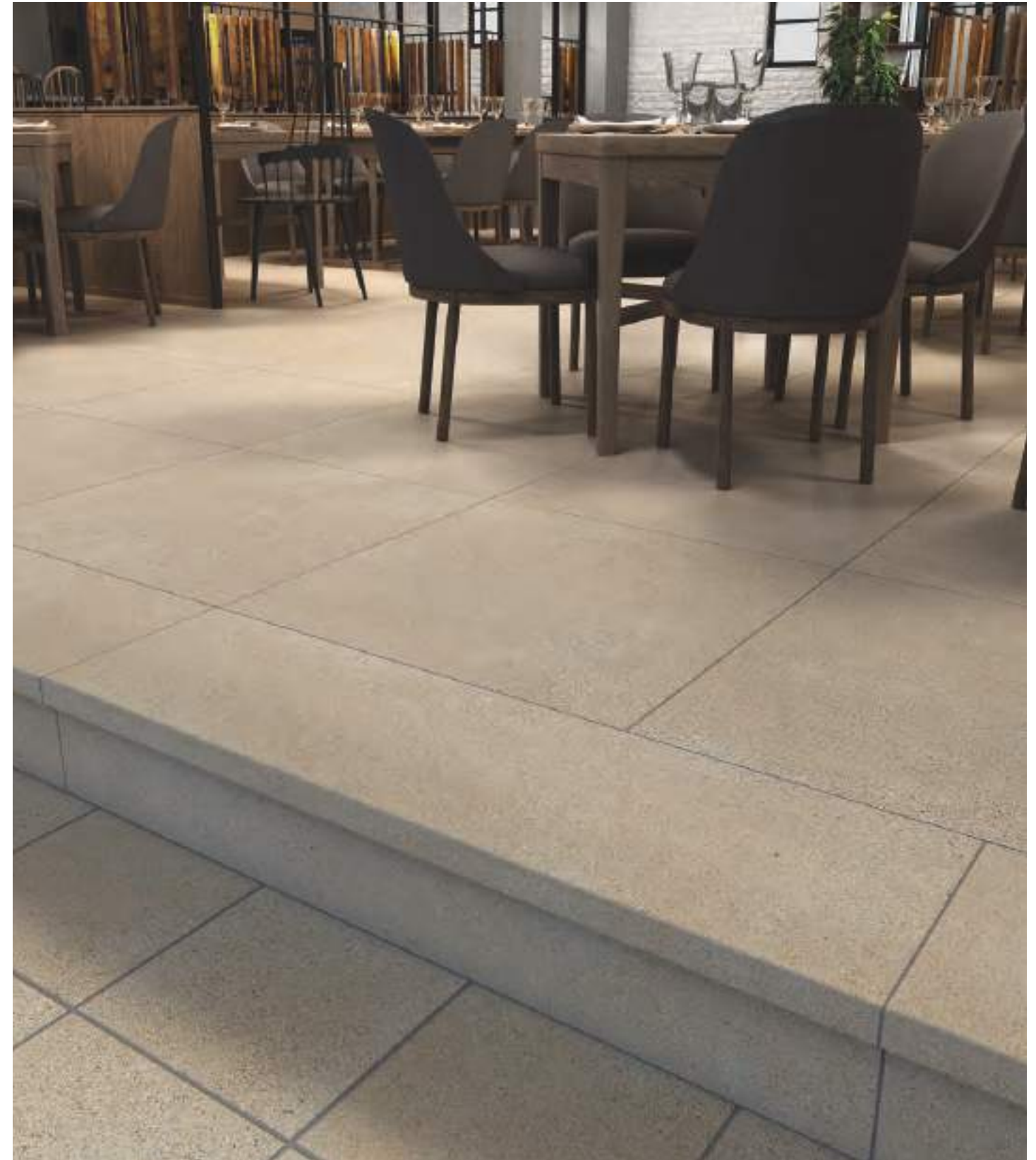



# MILÁN / GRIS

exagres  
TECHNICAL SOLUTIONS

GRES EXTRUIDO · EXTRUDED KLINKER · GRÈS EXTRUDÉ · ЭКСТРУДИРОВАННЫЙ КЕРАМОГРАНИТ  
GRES PORCELÁNICO · PORCELAIN STONEWARE · GRÈS PORCELAINÉ · КЕРАМОГРАНИТ



R9 C-1 Alb <1,5% V1  
R12 C-3 CLASE C Bla <0,5%

FORMATOS · SIZES · FORMATS · ФОРМАТЫ

PIEZAS ESPECIALES · SPECIAL PIECES · PIÈCES SPÉCIALES · СПЕЦИАЛЬНЫЕ ЭЛЕМЕНТЫ

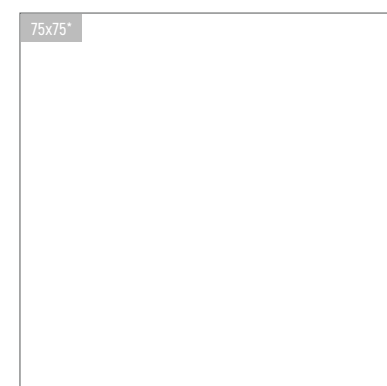
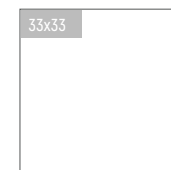

<b>75x75*</b> 75 x 75 cm - 29.5" x 29.5"	<b>14,5x120*</b> 14,5 x 120 cm - 5.7" x 47.2"	<b>33x33</b> 33 x 33 cm - 13.0" x 13.0"
11 mm rectificado, rectified C-1/C-3	10,2 mm rectificado, rectified C-1	10 mm C-3



**PELDAÑO RECTO 120**  
33 x 120 x 3 cm - 13.0" x 47.2" x 1.2"  
12 mm  
rectificado, rectified  
C-1/ C-3



**PELDAÑO RECTO**  
33 x 33 x 3 cm - 13.0" x 13.0" x 1.2"  
12 mm  
rectificado, rectified  
C-3



**REMATE PELDAÑO RECTO**  
3 x 33 cm - 1.2" x 13.0"



**RODAPIÉ**  
9 x 60 cm - 3.6" x 23.6"  
11 mm



**ZANQUÍN RECTO IZDA/DCHA**  
42,3 x 17,5 cm - 16.7" x 6.9"



**BORDE SKIMMER**  
45 x 75 x 3 cm - 17.7" x 29.5" x 1.2"  
rectificado, rectified  
C-3

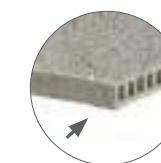

D. Continuidad gráfica, parte trasera.  
Graphic continuous, backside.



\* GRES PORCELÁNICO · PORCELAIN STONEWARE · GRÈS PORCELAINÉ · КЕРАМОГРАНИТ



# MILÁN / GRIS



OUTDOOR: MILÁN GRIS 75x75 CM (C-3) - BORDE SKIMMER 45x75x3 CM (C-3) - PELDAÑO RECTO MILÁN MARENGO 33x33 CM (C-3) - MILÁN MARENGO 33x33 CM (C-3)

INDOOR: MILÁN MARENGO 75x75 CM (C-1)





# MILÁN / GRIS

exagres

TECHNICAL SOLUTIONS

INDOOR: MILÁN GRIS 75x75 CM [C-1] - PELDAÑO RECTO 120 33x120x3 CM [C-1] - TABICA MILÁN GRIS 14,5x120 CM

OUTDOOR: MILÁN GRIS 33x33 CM [C-3]



# MILÁN / MARENGO

exagres  
TECHNICAL SOLUTIONS

GRES EXTRUIDO · EXTRUDED KLINKER · GRÈS EXTRUDÉ · ЭКСТРУДИРОВАННЫЙ КЕРАМОГРАНИТ  
GRES PORCELÁNICO · PORCELAIN STONEWARE · GRÈS PORCELAINÉ · КЕРАМОГРАНИТ



R9 C-1 Alb <1,5% V1  
R12 C-3 CLASE C Bla <0,5%

FORMATOS · SIZES · FORMATS · ФОРМАТЫ

PIEZAS ESPECIALES · SPECIAL PIECES · PIÈCES SPÉCIALES · СПЕЦИАЛЬНЫЕ ЭЛЕМЕНТЫ

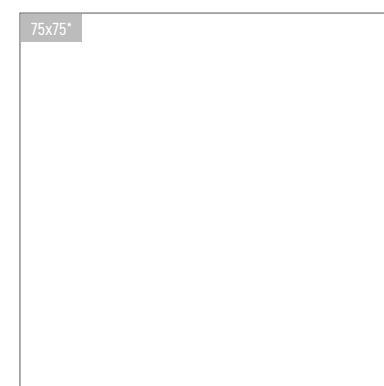
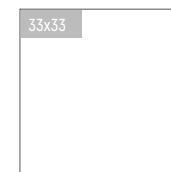

<b>75x75*</b> 75 x 75 cm - 29.5" x 29.5"	<b>14,5x120*</b> 14,5 x 120 cm - 5.7" x 47.2"	<b>33x33</b> 33 x 33 cm - 13.0" x 13.0"
11 mm rectificado, rectified C-1/C-3	10,2 mm rectificado, rectified C-1	10 mm C-3



**PELDAÑO RECTO 120**  
33 x 120 x 3 cm - 13.0" x 47.2" x 1.2"  
12 mm  
rectificado, rectified  
C-1/ C-3

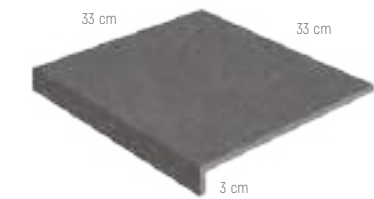

**PELDAÑO RECTO**  
33 x 33 x 3 cm - 13.0" x 13.0" x 1.2"  
12 mm  
rectificado, rectified  
C-3



**REMATE PELDAÑO RECTO**  
3 x 33 cm - 1.2" x 13.0"



**RODAPIÉ**  
9 x 60 cm - 3.6" x 23.6"  
11 mm



**ZANQUÍN RECTO IZDA/DCHA**  
42,3 x 17,5 cm - 16.7" x 6.9"



**BORDE SKIMMER**  
45 x 75 x 3 cm - 17.7" x 29.5" x 1.2"  
rectificado, rectified  
C-3

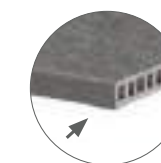

D. Continuidad gráfica, parte trasera.  
Graphic continuous, backside.

3D DESIGN

\* GRES PORCELÁNICO · PORCELAIN STONEWARE · GRÈS PORCELAINÉ · КЕРАМОГРАНИТ



# MILÁN / MARENGO



OUTDOOR: MILÁN MARENGO 75x75 CM [C-3] - BORDE SKIMMER 45x75x3 CM [C-3] - PELDAÑO RECTO 33x120x3 CM [C-3]

INDOOR: MILÁN MARENGO 75x75 CM [C-1]





# MILÁN / MARENGO

exagres

TECHNICAL SOLUTIONS

INDOOR: MILÁN MARENGO 75x75 CM (C-1) - PELDAÑO RECTO 120 33x120x3 CM (C-1) - TABICA MILÁN MARENGO 14,5x120 CM

WALL: MANHATTAN RED 5,75x24,5 CM (C-2)





STONE

# ALBAROC

NATURAL STONE ESSENCE  
IN&OUTDOOR  
STAIRS  
SWIMMINGPOOLS



COLORS:	SIZES (cm):	SIZES (inches):
BOAL	100x100 cm	39.4"x39.4"
GALENA	14,5x120 cm	5.7"x47.2"
HULLA	33x66,5 cm	13.0"x26.2"
HULLA	33x33 cm	13.0"x13.0"

OUTDOOR: ALBAROC HULLA 33x66,5 CM (C-3) - PELDAÑO RECTO 33x120x3 CM (C-3)

INDOOR: ALBAROC HULLA 33x66,5 CM (C-1)

# ALBAROC / BOAL



GRES EXTRUIDO · EXTRUDED KLINKER · GRÈS EXTRUDÉ · ЭКСТРУДИРОВАННЫЙ КЕРАМОГРАНИТ  
 GRES PORCELÁNICO · PORCELAIN STONEWARE · GRÈS PORCELAINÉ · КЕРАМОГРАНИТ



R10 C-1 Alb <1,5% V2  
 R12 C-3 Bla <0,5%



## FORMATOS · SIZES · FORMATS · ФОРМАТЫ

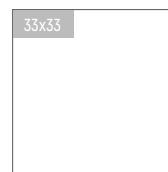
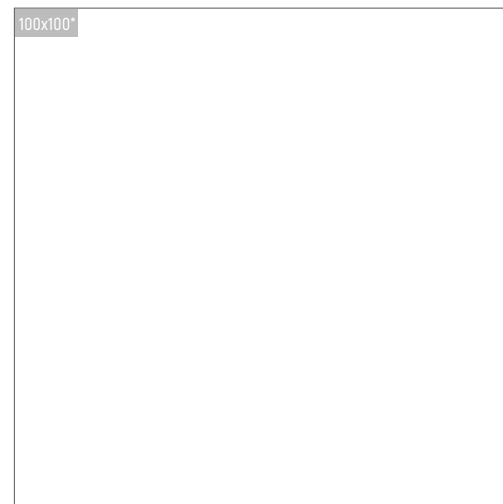

**100x100\***  
 100 x 100 cm -  
 39.4" x 39.4"

± 11 mm  
 rectificado, rectified  
 C-1/C-3

**14,5x120\***  
 14,5 x 120 cm -  
 5.7" x 47.2"

± 10,2 mm  
 rectificado, rectified  
 C-1

**33x66,5**  
 33 x 66,5 cm -  
 13.0" x 26.2"

± 10 mm  
 C-1/C-3

**33x33**  
 33 x 33 cm -  
 13.0" x 13.0"

± 10 mm  
 C-1/C-3

\* GRES PORCELÁNICO · PORCELAIN STONEWARE · GRÈS PORCELAINÉ · КЕРАМОГРАНИТ

## PIEZAS ESPECIALES · SPECIAL PIECES · PIÈCES SPÉCIALES · СПЕЦИАЛЬНЫЕ ЭЛЕМЕНТЫ



**PELDAÑO RECTO 120**  
 33 x 120 x 3 cm - 13.0" x 47.2" x 1.2"

± 12 mm  
 rectificado, rectified  
 C-3



**REMATE PELDAÑO RECTO**  
 3 x 33 cm - 1.2" x 13.0"



**PELDAÑO ML**  
 33 x 33 x 4 cm - 13.0" x 13.0" x 1.6"

± 13 mm  
 C-3



**CARTABÓN ML**  
 33 x 33 x 4 cm - 13.0" x 13.0" x 1.6"

± 14 mm  
 rectificado, rectified  
 C-3



**RODAPIÉ**  
 9 x 40 cm - 3.6" x 15.7"

± 15 mm



**ZANQUÍN ML IZDA./DCHA.**  
 18 x 40 cm - 7.1" x 15.7"

± 15 mm



**ZANQUÍN RECTO IZDA./DCHA.**  
 18 x 40 cm - 7.1" x 15.7"

± 15 mm



**PASAMANOS 12\***  
 12,5 x 66,5 x 4 cm - 4,9" x 26,2" x 1,6"



**PASAMANOS 15\***  
 15,5 x 66,5 x 4 cm - 6,1" x 26,2" x 1,6"

\*medidas interiores. inner measures.



# ALBAROC / BOAL

OUTDOOR: ALBAROC BOAL 33x66,5 CM [C-3] - PASAMANOS 15,5x66,5x4 CM

INDOOR: ALBAROC BOAL 33x33 CM [C-1] - PELDAÑO ML 33x33x4 CM [C-3] - CARTABÓN ML 33x33x4 CM [C-3]





# ALBAROC / GALENA

GRES EXTRUIDO · EXTRUDED KLINKER · GRÈS EXTRUDÉ · ЭКСТРУДИРОВАННЫЙ КЕРАМОГРАНИТ  
GRES PORCELÁNICO · PORCELAIN STONEWARE · GRÈS PORCELAINÉ · КЕРАМОГРАНИТ



R10 C-1 Alb <1,5% V2  
R12 C-3 Bla <0,5%

## FORMATOS · SIZES · FORMATS · ФОРМАТЫ

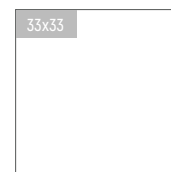
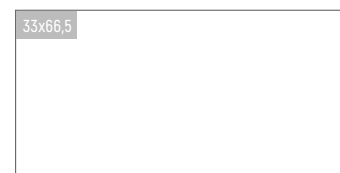
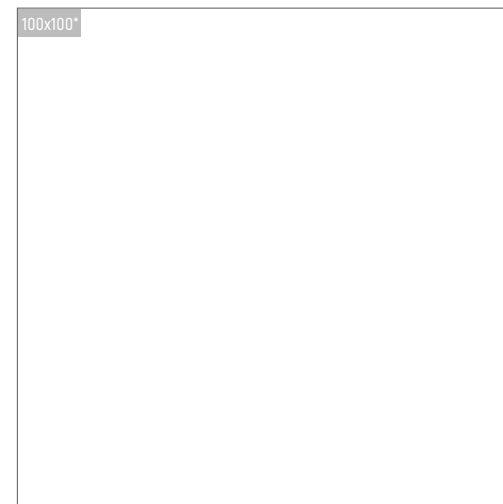

**100x100\***  
100 x 100 cm -  
39.4" x 39.4"

± 11 mm  
rectificado, rectified  
C-1/C-3

**14,5x120\***  
14,5 x 120 cm -  
5.7" x 47.2"

± 10,2 mm  
rectificado, rectified  
C-1

**33x66,5**  
33 x 66,5 cm -  
13.0" x 26.2"

± 10 mm  
C-1/C-3

**33x33**  
33 x 33 cm -  
13.0" x 13.0"

± 10 mm  
C-1/C-3

\* GRES PORCELÁNICO · PORCELAIN STONEWARE · GRÈS PORCELAINÉ · КЕРАМОГРАНИТ

## PIEZAS ESPECIALES · SPECIAL PIECES · PIÈCES SPÉCIALES · СПЕЦИАЛЬНЫЕ ЭЛЕМЕНТЫ



**PELDAÑO RECTO 120**  
33 x 120 x 3 cm - 13.0" x 47.2" x 1.2"  
± 12 mm  
rectificado, rectified  
C-3



**REMATE PELDAÑO RECTO**  
3 x 33 cm - 1.2" x 13.0"



**PELDAÑO ML**  
33 x 33 x 4 cm - 13.0" x 13.0" x 1.6"  
± 13 mm  
C-3



**CARTABÓN ML**  
33 x 33 x 4 cm - 13.0" x 13.0" x 1.6"  
± 14 mm  
rectificado, rectified  
C-3



**RODAPIÉ**  
9 x 40 cm - 3.6" x 15.7"  
± 15 mm



**ZANQUÍN ML IZDA./DCHA.**  
18 x 40 cm - 7.1" x 15.7"  
± 15 mm



**ZANQUÍN RECTO IZDA./DCHA.**  
18 x 40 cm - 7.1" x 15.7"  
± 15 mm



**PASAMANOS 12°**  
12,5 x 66,5 x 4 cm - 4.9" x 26.2" x 1.6"



**PASAMANOS 15°**  
15,5 x 66,5 x 4 cm - 6.1" x 26.2" x 1.6"

\*medidas interiores. inner measures.



# ALBAROC / GALENA

INDOOR: ALBAROC GALENA 100x100 CM (C-1) - ALBAROC GALENA 14,5x120 (C-1) - PELDAÑO RECTO 33x120x3 CM (C-3) - REMATE PELDAÑO RECTO 3x33 CM





# ALBAROC / HULLA



GRES EXTRUIDO · EXTRUDED KLINKER · GRÈS EXTRUDÉ · ЭКСТРУДИРОВАННЫЙ КЕРАМОГРАНИТ  
GRES PORCELÁNICO · PORCELAIN STONEWARE · GRÈS PORCELAINÉ · КЕРАМОГРАНИТ



R10 C-1 Alb <1,5% V2  
R12 C-3 Bla <0,5%



## FORMATOS · SIZES · FORMATS · ФОРМАТЫ

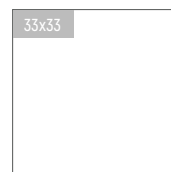
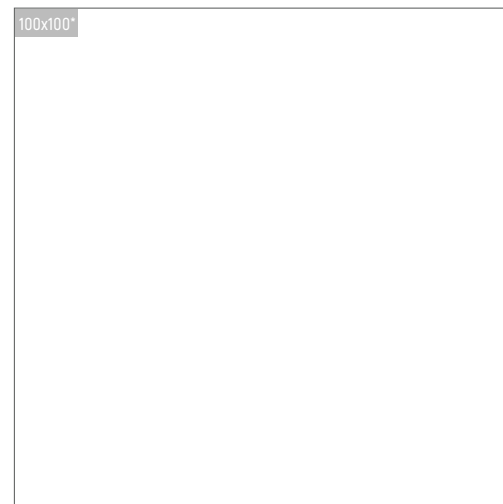

<b>100x100*</b> 100 x 100 cm - 39.4" x 39.4"	<b>14,5x120*</b> 14,5 x 120 cm - 5.7" x 47.2"	<b>33x66,5</b> 33 x 66,5 cm - 13.0" x 26.2"	<b>33x33</b> 33 x 33 cm - 13.0" x 13.0"
± 11 mm rectificado, rectified C-1/C-3	± 10,2 mm rectificado, rectified C-1	± 10 mm C-1/C-3	± 10 mm C-1/C-3

## PIEZAS ESPECIALES · SPECIAL PIECES · PIÈCES SPÉCIALES · СПЕЦИАЛЬНЫЕ ЭЛЕМЕНТЫ



**PELDAÑO RECTO 120**  
33 x 120 x 3 cm - 13.0" x 47.2" x 1.2"  
± 12 mm  
rectificado, rectified  
C-3



**REMATE PELDAÑO RECTO**  
3 x 33 cm - 1.2" x 13.0"



**PELDAÑO ML**  
33 x 33 x 4 cm - 13.0" x 13.0" x 1.6"  
± 13 mm  
C-3



**CARTABÓN ML**  
33 x 33 x 4 cm - 13.0" x 13.0" x 1.6"  
± 14 mm  
rectificado, rectified  
C-3



**RODAPIÉ**  
9 x 40 cm - 3.6" x 15.7"  
± 15 mm



**ZANQUÍN ML IZDA./DCHA.**  
18 x 40 cm - 7.1" x 15.7"  
± 15 mm



**ZANQUÍN RECTO IZDA./DCHA.**  
18 x 40 cm - 7.1" x 15.7"  
± 15 mm



**PASAMANOS 12\***  
12,5 x 66,5 x 4 cm - 4.9" x 26.2" x 1.6"



**PASAMANOS 15\***  
15,5 x 66,5 x 4 cm - 6.1" x 26.2" x 1.6"

\*medidas interiores. inner measures.

\* GRES PORCELÁNICO · PORCELAIN STONEWARE · GRÈS PORCELAINÉ · КЕРАМОГРАНИТ



# ALBAROC / HULLA

OUTDOOR: ALBAROC HULLA 100x100 CM (C-3) - ALBAROC HULLA 14,5x120 CM (C-1) - PELDAÑO RECTO 33x120x3 CM (C-3) - PASAMANOS 15,5x66,5x4 CM





STONE



# LITOS

STONE & CEMENT FUSION  
IN&OUTDOOR  
STAIRS  
LARGE FORMATS  
SWIMMINGPOOLS

COLORS:	SIZES (cm):	SIZES (inches):
ÁRTICO	100x100 cm	39.4"x39.4"
SABANA	60x120 cm	23.7"x47.2"
SIBERIA	14,5x120 cm	5.7"x47.2"
	33x66,5 cm	13.0"x26.2"



LITOS SIBERIA 33x66,5 CM [C-1/C-3] - LITOS SIBERIA 14,5x120 CM [C-1] - LITOS SIBERIA 60x120 CM [C-3] - BORDE DESBORDANTE 28x66,5 CM [C-3] -  
ÁNGULO DESBORDANTE 33x33 CM [C-3] - REJILLA 24,5x24,5 CM [C-3] - ÁNGULO REJILLA IZDA. DCHA. 24,5x33 CM [C-3] - MEDIA CAÑA 33x4 CM - UÑA 4x4 CM



# LITOS / ÁRTICO



GRES EXTRUIDO · EXTRUDED KLINKER · GRÈS EXTRUDÉ · ЭКСТРУДИРОВАННЫЙ КЕРАМОГРАНИТ  
GRES PORCELÁNICO · PORCELAIN STONWARE · GRÈS PORCELAINÉ · КЕРАМОГРАНИТ

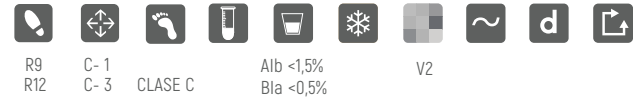

## FORMATOS · SIZES · FORMATS · ФОРМАТЫ

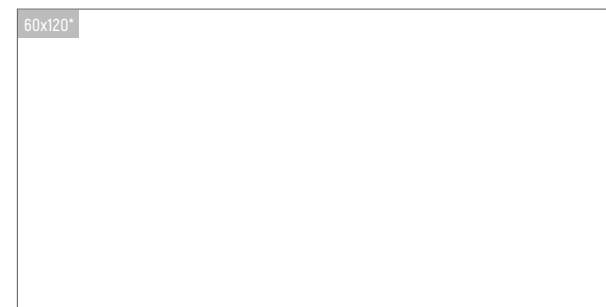
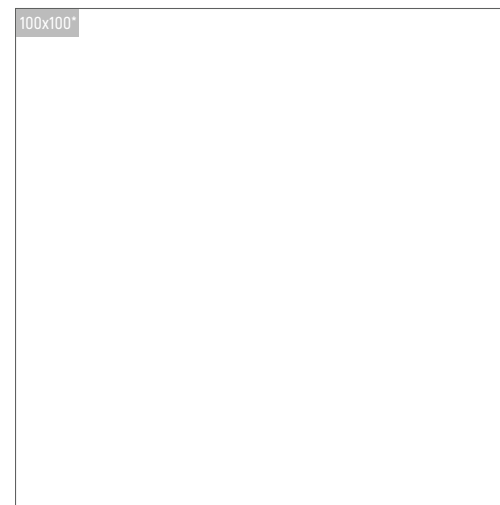

<b>100x100*</b> 100 x 100 cm - 39.4"x 39.4" x 11 mm rectificado, rectified C-1/C-3	<b>60x120*</b> 60 x 120 cm - 23.7"x 47.2" x 10,2 mm rectificado, rectified C-1/C-3	<b>14,5x120*</b> 14,5 x 120 cm - 5.7"x 47.2" x 10,2 mm rectificado, rectified C-1	<b>33x66,5</b> 33 x 66,5 cm - 13.0"x 26.2" x 10 mm rectificado, rectified C-1/C-3
---------------------------------------------------------------------------------------------------	---------------------------------------------------------------------------------------------------	--------------------------------------------------------------------------------------------------	--------------------------------------------------------------------------------------------------

## PIEZAS ESPECIALES · SPECIAL PIECES · PIÈCES SPÉCIALES · СПЕЦИАЛЬНЫЕ ЭЛЕМЕНТЫ



**PELDAÑO RECTO 120**  
 33 x 120 x 3 cm - 13.0"x 47.2"x 1.2"  
 x 12 mm  
 rectificado, rectified  
 C-3



**REMATE PELDAÑO RECTO**  
 3 x 33 cm - 1.2"x 13.0"



**RODAPIÉ**  
 9 x 40 cm - 3.6"x 15.7"  
 x 15 mm



**ZANQUÍN RECTO IZDA/DCHA**  
 40 x 18 cm - 15.7"x 7.1"  
 x 15 mm



**BORDE DESBORDANTE**  
 28 x 66,5 cm - 11.0"x26.2"  
 rectificado, rectified  
 C-3



**ÁNGULO DESBORDANTE**  
 31 x 31 cm - 12.2"x12.2"  
 rectificado, rectified  
 C-3



**REJILLA**  
 24,5 x 24,5 cm - 9.6"x9.6"  
 rectificado, rectified  
 C-3



**ÁNGULO REJILLA DERECHA\***  
 24,5 x 33 cm - 9.6"x13.0"  
 rectificado, rectified  
 C-3



**ÁNGULO REJILLA IZQUIERDA\***  
 24,5 x 33 cm - 9.6"x13.0"  
 rectificado, rectified  
 C-3

\*set de 2 piezas [izda./dcha.] \*two pieces set [left/right]



**MEDIA CAÑA**  
 33 x 4 cm - 13.0"x 1.6"  
 r-3 cm



**UÑA**  
 4 x 4 cm - 1.6"x 1.6"



**ARISTA**  
 33 x 3 cm - 13.0"x 1.2"  
 r-3 cm



**UÑA ARISTA**  
 3 x 3 cm - 1.2"x 1.2"

\* GRES PORCELÁNICO · PORCELAIN STONWARE · GRÈS PORCELAINÉ · КЕРАМОГРАНИТ



# LITOS / ÁRTICO

exagres

TECHNICAL SOLUTIONS

INDOOR: LITOS ÁRTICO 60x120 CM (C-3) / 33x66,5 CM (C-1) / 14,5x120 CM (C-1) - BORDE DESBORDANTE 28x66,5 CM (C-3) - ÁNGULO DESBORDANTE 33x33 CM (C-3) -

REJILLA 24,5x24,5 CM (C-3) - ÁNGULOS REJILLA 24,5x33 CM (C-3) - MEDIA CAÑA 33x4 CM - UÑA 4x4 CM

OUTDOOR: LITOS ÁRTICO 60x120 CM (C-3)





# LITOS / SABANA



GRES EXTRUIDO · EXTRUDED KLINKER · GRÈS EXTRUDÉ · ЭКСТРУДИРОВАННЫЙ КЕРАМОГРАНИТ  
GRES PORCELÁNICO · PORCELAIN STONWARE · GRÈS PORCELAINÉ · КЕРАМОГРАНИТ

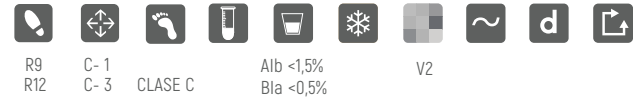

## FORMATOS · SIZES · FORMATS · ФОРМАТЫ

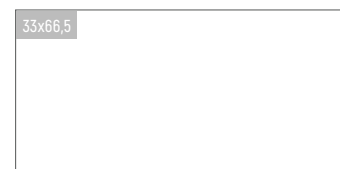
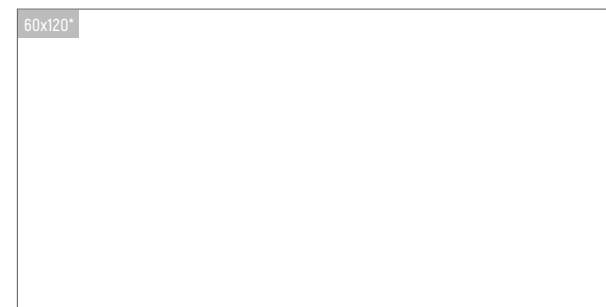
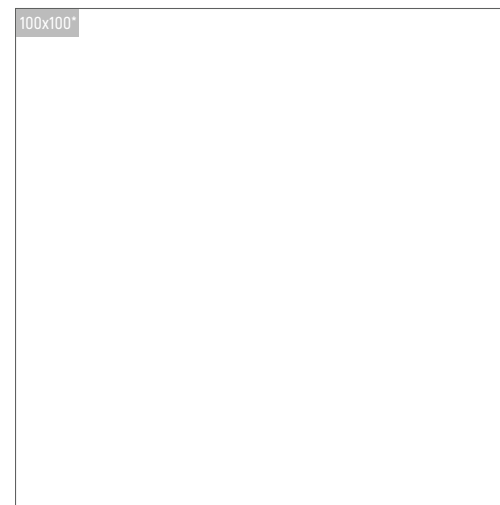

<b>100x100*</b> 100 x 100 cm - 39.4"x 39.4" x 11 mm rectificado, rectified C-1/C-3	<b>60x120*</b> 60 x 120 cm - 23.7"x 47.2" x 10,2 mm rectificado, rectified C-1/C-3	<b>14,5x120*</b> 14,5 x 120 cm - 5.7"x 47.2" x 10,2 mm rectificado, rectified C-1	<b>33x66,5</b> 33 x 66,5 cm - 13.0"x 26.2" x 10 mm rectificado, rectified C-1/C-3
---------------------------------------------------------------------------------------------------	---------------------------------------------------------------------------------------------------	--------------------------------------------------------------------------------------------------	--------------------------------------------------------------------------------------------------

## PIEZAS ESPECIALES · SPECIAL PIECES · PIÈCES SPÉCIALES · СПЕЦИАЛЬНЫЕ ЭЛЕМЕНТЫ



**PELDAÑO RECTO 120**  
 33 x 120 x 3 cm - 13.0"x 47.2"x 1.2"  
 x 12 mm  
 rectificado, rectified  
 C-3



**REMATE PELDAÑO RECTO**  
 3 x 33 cm - 1.2"x 13.0"



**RODAPIÉ**  
 9 x 40 cm - 3.6"x 15.7"  
 x 15 mm



**ZANQUÍN RECTO IZDA/DCHA**  
 40 x 18 cm - 15.7"x 7.1"  
 x 15 mm



**BORDE DESBORDANTE**  
 28 x 66,5 cm - 11.0"x 26.2"  
 rectificado, rectified  
 C-3



**ÁNGULO DESBORDANTE**  
 31 x 31 cm - 12.2"x 12.2"  
 rectificado, rectified  
 C-3



**REJILLA**  
 24,5 x 24,5 cm - 9.6"x 9.6"  
 rectificado, rectified  
 C-3



**ÁNGULO REJILLA DERECHA\***  
 24,5 x 33 cm - 9.6"x 13.0"  
 rectificado, rectified  
 C-3



**ÁNGULO REJILLA IZQUIERDA\***  
 24,5 x 33 cm - 9.6"x 13.0"  
 rectificado, rectified  
 C-3

\*set de 2 piezas [izda./dcha.] \*two pieces set [left/right]



**MEDIA CAÑA**  
 33 x 4 cm - 13.0"x 1.6"  
 r-3 cm



**UÑA**  
 4 x 4 cm - 1.6"x 1.6"  
 r-3 cm



**ARISTA**  
 33 x 3 cm - 13.0"x 1.2"  
 r-3 cm



**UÑA ARISTA**  
 3 x 3 cm - 1.2"x 1.2"

\* GRES PORCELÁNICO · PORCELAIN STONWARE · GRÈS PORCELAINÉ · КЕРАМОГРАНИТ



# LITOS / SABANA

OUTDOOR: LITOS SABANA 33x66,5 CM (C-3) / 14,5x120 CM (C-1) - PELDAÑO RECTO 33x120x3 CM (C-3) - BORDE DESBORDANTE 28x66,5 CM (C-3) - ÁNGULO DESBORDANTE 33x33 CM (C-3)

REJILLA 24,5x24,5 CM (C-3) - ÁNGULOS REJILLA 24,5x33 CM (C-3) - LITOS SABANA 33x66,5 CM (C-1)

INDOOR: LITOS SABANA 60x120 CM (C-1)





# LITOS / SIBERIA



GRES EXTRUIDO · EXTRUDED KLINKER · GRÈS EXTRUDÉ · ЭКСТРУДИРОВАННЫЙ КЕРАМОГРАНИТ  
 \*GRES PORCELÁNICO · PORCELAIN STONEWARE · GRÈS PORCELAINÉ · КЕРАМОГРАНИТ

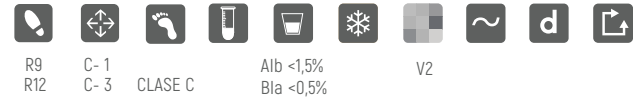

## FORMATOS · SIZES · FORMATS · ФОРМАТЫ

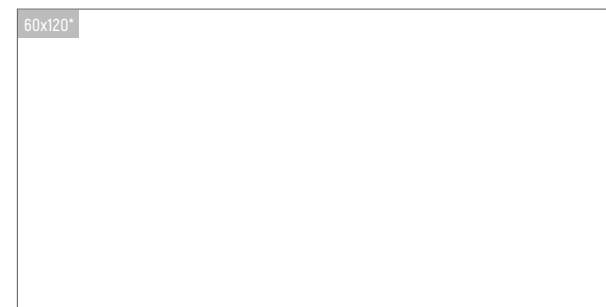
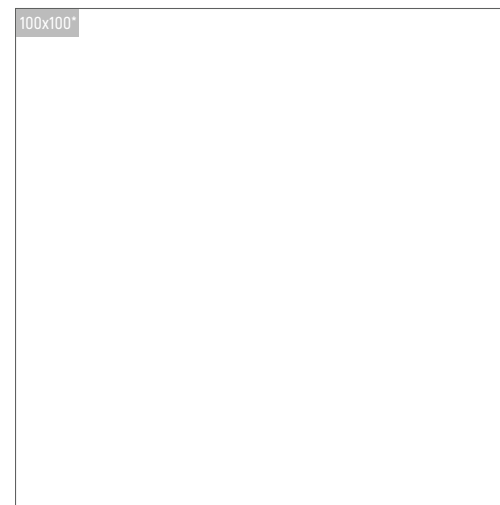

<b>100x100*</b> 100 x 100 cm - 39.4"x 39.4" x 11 mm rectificado, rectified C-1/C-3	<b>60x120*</b> 60 x 120 cm - 23.7"x 47.2" x 10,2 mm rectificado, rectified C-1/C-3	<b>14,5x120*</b> 14,5 x 120 cm - 5.7"x 47.2" x 10,2 mm rectificado, rectified C-1	<b>33x66,5</b> 33 x 66,5 cm - 13.0"x 26.2" x 10 mm rectificado, rectified C-1/C-3
---------------------------------------------------------------------------------------------------	---------------------------------------------------------------------------------------------------	--------------------------------------------------------------------------------------------------	--------------------------------------------------------------------------------------------------

## PIEZAS ESPECIALES · SPECIAL PIECES · PIÈCES SPÉCIALES · СПЕЦИАЛЬНЫЕ ЭЛЕМЕНТЫ



**PELDAÑO RECTO 120**  
 33 x 120 x 3 cm - 13.0"x 47.2"x 1.2"  
 x 12 mm  
 rectificado, rectified  
 C-3



**REMATE PELDAÑO RECTO**  
 3 x 33 cm - 1.2"x 13.0"



**RODAPIÉ**  
 9 x 40 cm - 3.6"x 15.7"  
 x 15 mm



**ZANQUÍN RECTO IZDA/DCHA**  
 40 x 18 cm - 15.7"x 7.1"  
 x 15 mm



**BORDE DESBORDANTE**  
 28 x 66,5 cm - 11.0"x26.2"  
 rectificado, rectified  
 C-3



**ÁNGULO DESBORDANTE**  
 31 x 31 cm - 12.2"x12.2"  
 rectificado, rectified  
 C-3



**REJILLA**  
 24,5 x 24,5 cm - 9.6"x9.6"  
 rectificado, rectified  
 C-3



**ÁNGULO REJILLA DERECHA\***  
 24,5 x 33 cm - 9.6"x13.0"  
 rectificado, rectified  
 C-3



**ÁNGULO REJILLA IZQUIERDA\***  
 24,5 x 33 cm - 9.6"x13.0"  
 rectificado, rectified  
 C-3

\*set de 2 piezas [izda./dcha.] \*two pieces set (left/right)



**MEDIA CAÑA**  
 33 x 4 cm - 13.0"x 1.6"  
 r-3 cm



**UÑA**  
 4 x 4 cm - 1.6"x 1.6"



**ARISTA**  
 33 x 3 cm - 13.0"x 1.2"  
 r-3 cm



**UÑA ARISTA**  
 3 x 3 cm - 1.2"x 1.2"

\*GRES PORCELÁNICO · PORCELAIN STONEWARE · GRÈS PORCELAINÉ · КЕРАМОГРАНИТ

# LITOS / SIBERIA

INDOOR: LITOS SIBERIA 100x100 CM (C-1) / 60x120 CM (C-1) / 14,5x120 CM (C-1) - PELDAÑO RECTO 33x120x3 CM (C-3) - REMATE PELDAÑO RECTO 3x33 CM





STONE

# ROCA

QUARTZ INSPIRATION  
IN&OUTDOOR  
STAIRS  
SWIMMINGPOOLS

exagres

TECHNICAL SOLUTIONS

COLORS:            SIZES (cm):            SIZES (inches):

POLAR            33x66,5 cm            13.0"x26.2"  
                      33x33 cm             13.0"x13.0"

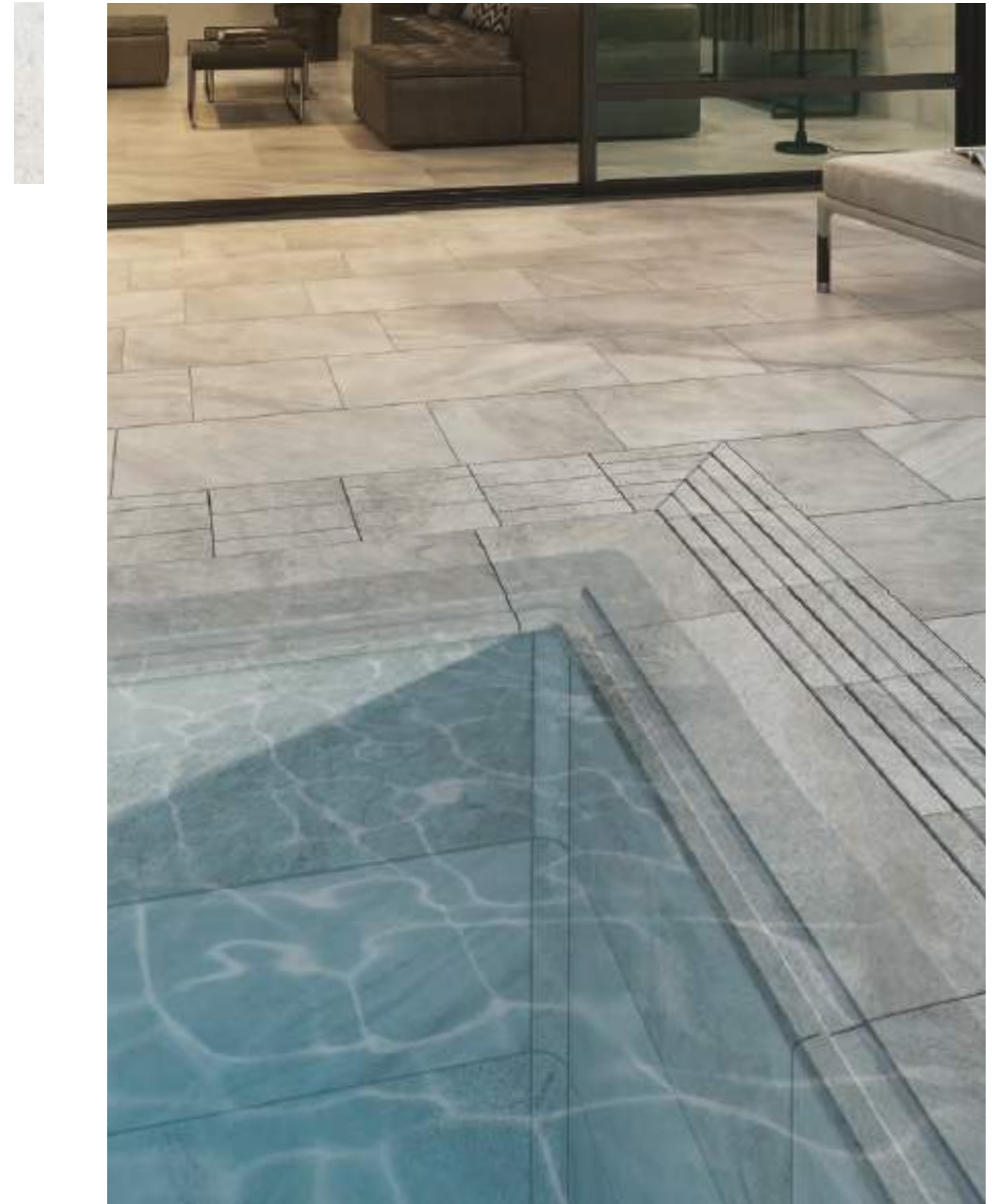

ROCA POLAR 33x66,5 CM (C-1/C-3) / 33x33 CM (C-3) - BORDE DESBORDANTE 28x66,5 CM (C-3) - ÁNGULO DESBORDANTE 33x33 CM (C-3) - REJILLA 24,5x24,5 CM (C-3) - ÁNGULO REJILLA IZDA. DCHA. 24,5x33 CM (C-3) - MEDIA CAÑA 33x4 CM

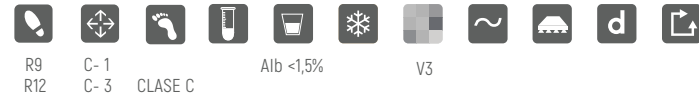

FORMATOS · SIZES · FORMATS · ФОРМАТЫ

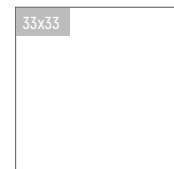

**33x66,5**  
33 x 66,5 cm - 13.0" x 26.2"  
± 10 mm  
C-1/C-3

**33x33**  
33 x 33 cm - 13.0" x 13.0"  
± 10 mm  
C-3

PIEZAS ESPECIALES · SPECIAL PIECES · PIÈCES SPÉCIALES · СПЕЦИАЛЬНЫЕ ЭЛЕМЕНТЫ



**PELDAÑO ML**  
33 x 33 x 4 cm - 13.0" x 13.0" x 1.6"  
± 13 mm  
C-3



**CARTABÓN ML**  
33 x 33 x 4 cm - 13.0" x 13.0" x 1.6"  
± 14 mm  
rectificado, rectified  
C-3



**PELDAÑO RECTO**  
33 x 33 x 3 cm - 13.0" x 13.0" x 1.2"  
± 12 mm  
C-1 / C-3



**RODAPIÉ**  
9 x 33 cm - 3.5" x 13.0"  
± 11 mm



**ZANQUÍN ML IZDA./DCHA.**  
39,5 x 17,5 cm - 15.6" x 6.9"



**ZANQUÍN RECTO IZDA./DCHA.**  
42,3 x 17,5 cm - 16.7" x 6.9"



**BORDE DESBORDANTE**  
28 x 66,5 cm - 11.0" x 26.2"  
rectificado, rectified  
C-3



**ÁNGULO DESBORDANTE**  
31 x 31 cm - 12.2" x 12.2"  
rectificado, rectified  
C-3



**REJILLA**  
24,5 x 24,5 cm - 9.6" x 9.6"  
rectificado, rectified  
C-3



**ÁNGULO REJILLA DERECHA\***  
24,5 x 33 cm - 9.6" x 13.0"  
rectificado, rectified  
C-3



**ÁNGULO REJILLA IZQUIERDA\***  
24,5 x 33 cm - 9.6" x 13.0"  
rectificado, rectified  
C-3

\*set de 2 piezas [izda./dcha.] \*two pieces set [left/right]



**MEDIA CAÑA**  
33 x 4 cm - 13.0" x 1.6"  
r-3 cm



**UÑA**  
4 x 4 cm - 1.6" x 1.6"



**ARISTA**  
33 x 3 cm - 13.0" x 1.2"  
r-3 cm



**UÑA ARISTA**  
3 x 3 cm - 1.2" x 1.2"



# ROCA / POLAR

exagres

TECHNICAL SOLUTIONS

OUTDOOR: ROCA POLAR 33x33 CM (C-3) / 33x66,5 CM (C-3) - PELDAÑO RECTO 33x33x3 CM (C-3) - BORDE DESBORDANTE 28x66,5 CM (C-3) - REJILLA 24,5x24,5 CM (C-3)

INDOOR: ROCA POLAR 33x66,5 CM (C-1)





STONE



# MANHATTAN

TRENDS AND TECHNICAL  
SOLUTIONS IN EXTRUDED  
BRICK  
SMALL FORMAT  
STAIRS

COLORS:	SIZES (cm):	SIZES (inches):
WHITE		
GREY	24,5x24,5 cm	9.6"x9.6"
MINK	12x24,5 cm	4.7"x9.6"
RED	5,75x24,5 cm	2.3"x9.6"



OUTDOOR: MANHATTAN GREY 24,5x24,5 CM [ C-2] - FAÇADE: MANHATTAN GREY 5,75x24,5 CM [C-2]



# MANHATTAN /

GRES EXTRUIDO · EXTRUDED KLINKER · GRÈS EXTRUDÉ · ЭКСТРУДИРОВАННЫЙ КЕРАМОГРАНИТ

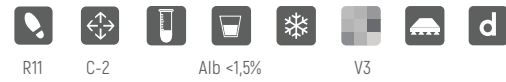

WHITE

GREY

MINK

RED



# WHITE / GREY / MINK / RED



## FORMATOS · SIZES · FORMATS · ФОРМАТЫ

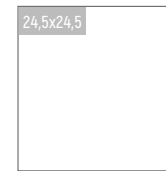

**24,5x24,5**  
24,5 x 24,5 cm - 9.6"x 9.6"  
± 9 mm  
C-2



**12x24,5**  
12 x 24,5 cm - 4.7"x 9.6"  
± 9 mm  
C-2



**5,75x24,5\***  
5,75 x 24,5 cm - 2.3"x9.6"  
± 9 mm  
C-2

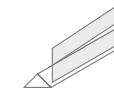

\*El brick 5,75x24,5 se consigue de la plaqueta doble de precorte que se separa en obra.  
The 5,75 x 24,5 brick is achieved from the double pre-cut plate that is separated on site.  
Le brick 5,75 x 24,5 s'obtient par la double plaque de pré-découpage qui se sépare en construction.  
Плитка 5,75 x 24,5 см получается из двойной пластины с предварительно сделанным пазом, которая разделяется при выполнении облицовочных работ.

## PIEZAS ESPECIALES · SPECIAL PIECES · PIÈCES SPÉCIALES · СПЕЦИАЛЬНЫЕ ЭЛЕМЕНТЫ



**PELDAÑO ML**  
24,5 x 33 x 4 cm - 9.6"x 13.0"x1.6"  
± 13 mm  
C-2



**CARTABÓN ML**  
33 x 33 x 4 cm - 13.0"x 13.0"x1.6"  
± 14 mm  
C-2  
rectificado, rectified



**ZANQUIN ML IZDA./DCHA.**  
39,5 x 17,5 cm - 15.6"x 6.9"



**RODAPIÉ**  
9 x 24,5 cm - 3.6"x 9.6"  
± 11 mm



**VIERTEAGUAS**  
15 x 24,5 x 4 cm - 5.9"x9.6"x1.6"  
± 10 mm



# MANHATTAN / WHITE

INDOOR: MANHATTAN WHITE 24,5x24,5 CM - MANHATTAN WHITE 12x24,5 CM - MANHATTAN WHITE 5,75x24,5 CM



# MANHATTAN / GREY

OUTDOOR: MANHATTAN GREY 24,5x24,5 CM - PELDAÑO ML 24,5x33x4 CM - CARTABÓN ML 33x33x4 CM - VIERTEAGUAS 15x24,5x4 CM





# MANHATTAN / MINK

INDOOR: MANHATTAN MINK 12x24,5 CM - MANHATTAN MINK 5,75x24,5 CM - PELDAÑO ML 24,5x33x4 CM - CARTABÓN ML 33x33x4 CM



# MANHATTAN / RED

OUTDOOR: MANHATTAN RED 24,5x24,5 CM / 12x24,5 CM / 5,75x24,5 CM - VIERTEAGUAS 15x24,5x4 CM FAÇADE: MANHATTAN RED 24,5x24,5 CM - 12x24,5 CM





STONE

# PETRA

STONE GRAPH EXTRUDED  
STAIRS  
SWIMMINGPOOLS

exagres

TECHNICAL SOLUTIONS



COLORS:      SIZES (cm):      SIZES (inches):

BONE		
OCRE		
GRIS	33x33 cm	13.0"x13.0"

PETRA GRIS 33x33 CM [C-3] - BORDE PISCINA 28x33 CM [C-3] - ÁNG. INTERIOR PISCINA 33x33 CM [C-3] - PELDAÑO FIORENTINO 33x33x3 CM [C-3]



# PETRA /

GRES EXTRUIDO · EXTRUDED KLINKER · GRÈS EXTRUDÉ · ЭКСТРУДИРОВАННЫЙ КЕРАМОГРАНИТ

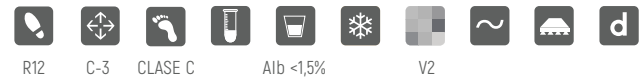

BONE

OCRE

GRIS



FORMATOS · SIZES · FORMATS · ФОРМАТЫ

# BONE / OCRE / GRIS



DECORADOS · DECORS · DÉCORÉ · УКРАШЕН



**TABICA PETRA ETNA**  
15 x 33 cm - 5.9"x 13.0"

± 10 mm



**TACO PETRA ETNA**  
8 x 8 cm - 3.15"x 3.15"

± 10 mm

PIEZAS ESPECIALES · SPECIAL PIECES · PIÈCES SPÉCIALES · СПЕЦИАЛЬНЫЕ ЭЛЕМЕНТЫ



**PELDAÑO FIORENTINO**  
33 x 33 x 3 cm - 13.0"x 13.0"x 1.2"

± 12 mm

C-3



**CARTABÓN FIORENTINO**  
33 x 33 x 3 cm - 13.0"x 13.0"x 1.2"

± 14 mm

C-3

rectificado. rectified



**ZANQUIN FIORENTINO IZDA./DCHA.**  
39,5 x 17,5 cm - 15.6"x 6.9"



**RODAPIÉ**  
9 x 33 cm - 3.6"x 13.0"

± 11 mm



**BORDE PISCINA**  
28 x 33 cm - 11.0"x 13.0"

C-3



**ÁNGULO INTERIOR PISCINA**  
33 x 33 cm - 13.0"x 13.0"

C-3

rectificado. rectified



**ÁNGULO EXTERIOR PISCINA**  
28 x 28 cm - 11.0"x 11.0"

C-3

rectificado. rectified

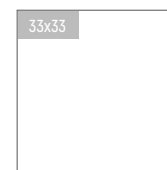

**33x33**  
33 x 33 cm - 13.0"x 13.0"

± 10 mm

C-3



# PETRA / BONE

OUTDOOR: PETRA BONE 33x33 CM (C-3)



# PETRA / GRIS

OUTDOOR: PETRA GRIS 33x33 CM (C-3)





STONE

# VEGA

SOFT STONE WITH RELIEF  
INDOOR  
STAIRS

COLORS:	SIZES (cm):	SIZES (inches):
VISÓN		
GRIS		
ROJO		
OCRE	33x33 cm	13.0"x13.0"



VEGA OCRE 33x33 CM (C-1) - RODAPIÉ 9x33 CM

# VEGA /

GRES EXTRUIDO · EXTRUDED KLINKER · GRÈS EXTRUDÉ · ЭКСТРУДИРОВАННЫЙ КЕРАМОГРАНИТ

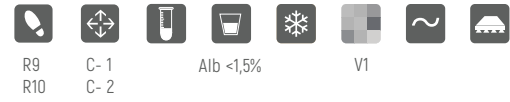

VISÓN

GRIS

ROJO

OCRE



## VISÓN / GRIS / ROJO / OCRE



FORMATOS · SIZES · FORMATS · ФОРМАТЫ

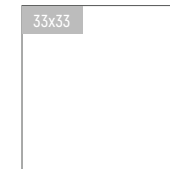

**33x33**  
33 x 33 cm - 13.0" x 13.0"  
± 10 mm  
■ C-1 / C-2

PIEZAS ESPECIALES · SPECIAL PIECES · PIÈCES SPÉCIALES · СПЕЦИАЛЬНЫЕ ЭЛЕМЕНТЫ



**PELDAÑO FIORENTINO**  
33 x 33 x 3 cm - 13.0" x 13.0" x 1.2"  
± 12 mm  
■ C-1/C-2

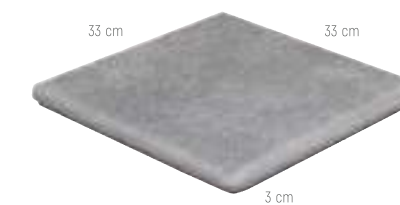

**CARTABÓN FIORENTINO**  
33 x 33 x 3 cm - 13.0" x 13.0" x 1.2"  
± 14 mm  
■ C-1/C-2  
■ rectificado. rectified

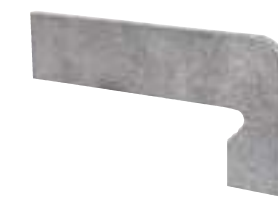

**ZANQUIN FIORENTINO IZDA./DCHA.**  
39,5 x 17,5 cm - 15.6" x 6.9"



**RODAPIÉ**  
9 x 33 cm - 3.6" x 13.0"  
± 11 mm



**VIERTEAGUAS**  
12 x 33 x 3 cm - 3.6" x 13.0" x 1.2"  
± 12 mm



# LUCCA

RUSTIC & MEDITERRANEAN SPIRIT  
IN&OUTDOOR  
MULTIFORMAT  
STAIRS  
SWIMMINGPOOLS

COLORS:	SIZES (cm):	SIZES (inches):
TERRA	33x33 cm	13.0"x13.0"
GRIGIO	16,25x33 cm	6.4"x13.0"
	16,25x16,25 cm	6.4"x6.4"

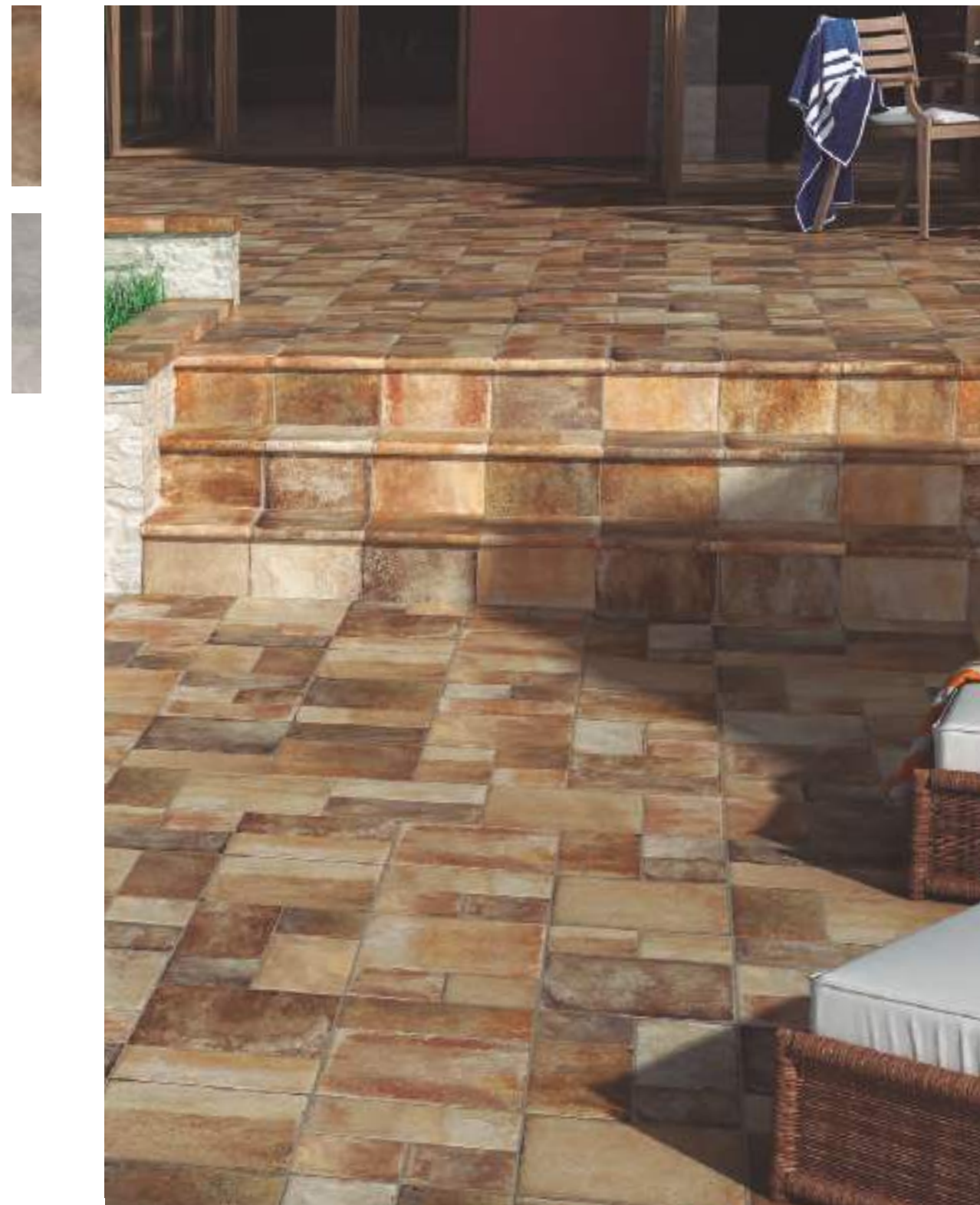

LUCCA TERRA 33x33 CM [C-3] / 16,25x33 CM [C-3] / 16,25x16,25 CM [C-3] - VIERTEAGUAS 15x33x4 CM - PELDAÑO ML 33x33x4 CM [C-3]

# LUCCA / TERRA

GRES EXTRUIDO · EXTRUDED KLINKER · GRÈS EXTRUDÉ · ЭКСТРУДИРОВАННЫЙ КЕРАМОГРАНИТ

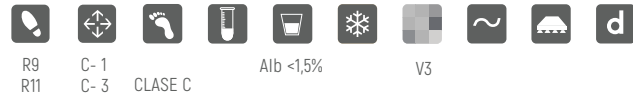

## FORMATOS · SIZES · FORMATS · ФОРМАТЫ

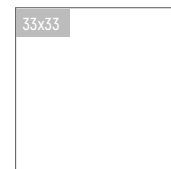

**33x33**  
33 x 33 cm - 13.0" x 13.0"  
x 10 mm  
C-1 / C-3

**16,25x33**  
16,25 x 33 cm - 6.4" x 13.0"  
x 10 mm  
C-3

**16,25x16,25**  
16,25 x 16,25 cm - 6.4" x 6.4"  
x 10 mm  
C-3

## PIEZAS ESPECIALES · SPECIAL PIECES · PIÈCES SPÉCIALES · СПЕЦИАЛЬНЫЕ ЭЛЕМЕНТЫ



**PELDAÑO ML**  
33 x 33 x 4 cm - 13.0" x 13.0" x 1.6"  
x 13 mm  
C-3



**CARTABÓN ML**  
33 x 33 x 4 cm - 13.0" x 13.0" x 1.6"  
x 14 mm  
rectificado, rectified  
C-3



**RODAPIÉ**  
9 x 33 cm - 3.5" x 13.0"  
x 11 mm



**ZANQUÍN ML IZDA./DCHA.**  
39,5 x 17,5 cm - 15.6" x 6.9"



**VIERTEAGUAS**  
15 x 33 x 4 cm - 5.9" x 13.0" x 1.6"  
C-3



**BORDE PISCINA**  
28 x 33 cm - 11.0" x 13.0"  
C-3



**ÁNGULO INTERIOR PISCINA**  
33 x 33 cm - 13.0" x 13.0"  
rectificado, rectified  
C-3

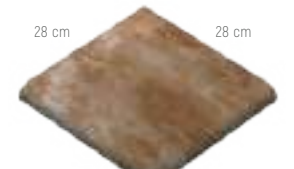

**ÁNGULO EXTERIOR PISCINA**  
28 x 28 cm - 11.0" x 11.0"  
rectificado, rectified  
C-3



# LUCCA / TERRA

OUTDOOR: LUCCA TERRA 33x33 CM (C-3) / 16,25x33 CM (C-3) / 16,25x16,25 CM (C-3) - VIERTEAGUAS 15x33x4 CM - PELDAÑO ML 33x33x4 CM (C-3) - BORDE SKIMMER 28x33 CM (C-3)

ÁNGULO INTERIOR PISCINA 33x33 CM





# LUCCA / GRIGIO

GRES EXTRUIDO · EXTRUDED KLINKER · GRÈS EXTRUDÉ · ЭКСТРУДИРОВАННЫЙ КЕРАМОГРАНИТ

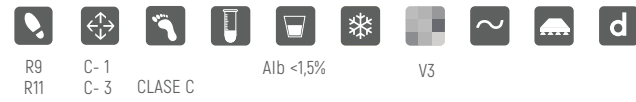

## FORMATOS · SIZES · FORMATS · ФОРМАТЫ

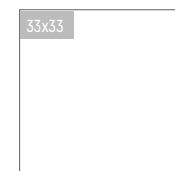

**33x33**  
33 x 33 cm - 13.0" x 13.0"  
x 10 mm  
C-1 / C-3

**16,25x33**  
16,25 x 33 cm - 6.4" x 13.0"  
x 10 mm  
C-3

**16,25x16,25**  
16,25 x 16,25 cm - 6.4" x 6.4"  
x 10 mm  
C-3

## PIEZAS ESPECIALES · SPECIAL PIECES · PIÈCES SPÉCIALES · СПЕЦИАЛЬНЫЕ ЭЛЕМЕНТЫ



**PELDAÑO ML**  
33 x 33 x 4 cm - 13.0" x 13.0" x 1.6"  
x 13 mm  
C-3



**CARTABÓN ML**  
33 x 33 x 4 cm - 13.0" x 13.0" x 1.6"  
x 14 mm  
rectificado, rectified  
C-3



**RODAPIÉ**  
9 x 33 cm - 3.5" x 13.0"  
x 11 mm



**ZANQUÍN ML IZDA./DCHA.**  
39,5 x 17,5 cm - 15.6" x 6.9"



**VIERTEAGUAS**  
15 x 33 x 4 cm - 5.9" x 13.0" x 1.6"  
C-3



**BORDE PISCINA**  
28 x 33 cm - 11.0" x 13.0"  
C-3



**ÁNGULO INTERIOR PISCINA**  
33 x 33 cm - 13.0" x 13.0"  
rectificado, rectified  
C-3



**ÁNGULO EXTERIOR PISCINA**  
28 x 28 cm - 11.0" x 11.0"  
rectificado, rectified  
C-3



# LUCCA / GRIGIO

INDOOR: LUCCA GRIGIO 33x33 CM (C-1) / 16,25x33 CM - PELDAÑO ML 33x33x4 CM - ZANQUÍN ML DCHA. 39,5x17,5 CM - RODAPIÉ 9x33 CM



# ALHAMAR

THE AGEING EFFECT OF NATURAL CLAY  
IN&OUTDOOR  
MULTIFORMAT  
STAIRS  
DECORS

COLORS:	SIZES (cm):	SIZES (inches):
BLANCO		
PAJA	33x33 cm	13.0"x13.0"
SALMÓN	16,25x33 cm	6.4"x13.0"
ROJO	16,25x16,25 cm	6.4"x6.4"



OUTDOOR: ALHAMAR BLANCO 33x33 CM [C-3] - PELDAÑO FIORENTINO BLANCO 33x33x3 CM [C-3]

INDOOR: ALHAMAR BLANCO 33x33 CM [C-1]





BLANCO PAJA SALMÓN ROJO



FORMATOS · SIZES · FORMATS · ФОРМАТЫ



**33x33**  
33 x 33 cm -  
13.0" x 13.0"

10 mm  
C-1 / C-3

**16,25x33**  
16,25 x 33 cm -  
6.4" x 13.0"

10 mm  
C-3

**16,25x16,25**  
16,25 x 16,25 cm -  
6.4" x 6.4"

10 mm  
C-3

DECORADOS · DECORATED · DÉCORÉ · УКРАШЕН



**DECORATIVE**  
33 x 33 cm - 13.0" x 13.0"

10 mm  
C-3



\*1 set 4 piezas - 4 pieces pack



**CLAY**  
33 x 33 cm - 13.0" x 13.0"

10 mm  
C-3



\*1 set 2 piezas - 2 pieces pack



**TABICA CLAY**  
15 x 33 cm - 5.9" x 13.0"

10 mm  
C-3



\*1 set 2 piezas - 2 pieces pack

PIEZAS ESPECIALES · SPECIAL PIECES · PIÈCES SPÉCIALES · СПЕЦИАЛЬНЫЕ ЭЛЕМЕНТЫ

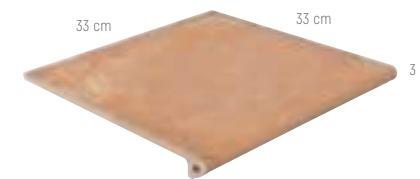

**PELDAÑO FIORENTINO**  
33 x 33 x 3 cm - 13.0" x 13.0" x 1.2"

12 mm  
C-3



**CARTABÓN FIORENTINO**  
33 x 33 x 3 cm - 13.0" x 13.0" x 1.2"

14 mm  
C-3  
rectificado, rectified



**RODAPIÉ**  
9 x 33 cm - 3.5" x 13.0"

11 mm



**ZANQUÍN FIORENTINO IZDA./DCHA.**  
39,5 x 17,5 cm - 15.6" x 6.9"



**VIERTEAGUAS**  
15 x 33 x 4 cm - 5.9" x 13.0" x 1.6"

10 mm  
C-3



# ALHAMAR / SALMÓN

OUTDOOR: ALHAMAR SALMÓN 33x33 CM [C-3] / 16,25x33 CM [C-3] - PELDAÑO FIORENTINO 33x33x3 CM [C-3] - CARTABÓN FIORENTINO 33x33x3 CM



# ALHAMAR / ROJO

INDOOR: ALHAMAR ROJO 33x33 CM [C-1] - DECORATIVE ROJO 33x33 CM [C-3]



OUTDOOR: ALHAMAR ROJO 33x33 CM [C-3] - VIERTEAGUAS 15x33x4 CM





METAL

# METÁLICA

DESIGN AND METALLIC EFFECTS  
INDOOR  
STAIRS

COLORS:	SIZES (cm):	SIZES (inches):
PURPLE		
CHERRY		
BASALT		
VULCANO	33x33 cm	13.0"x13.0"



INDOOR: METÁLICA VULCANO 33x33 CM - PELDAÑO FIORENTINO 33x33x3 CM



# METÁLICA /

GRES EXTRUIDO · EXTRUDED KLINKER · GRÈS EXTRUDÉ · ЭКСТРУДИРОВАННЫЙ КЕРАМОГРАНИТ

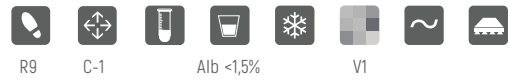

VULCANO

CHERRY

BASALT

PURPLE



# VULCANO / CHERRY / BASALT / PURPLE



FORMATOS · SIZES · FORMATS · ФОРМАТЫ

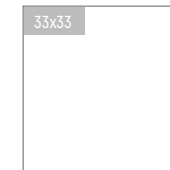

**33x33**  
33 x 33 cm - 13.0" x 13.0"  
± 10 mm  
C-1

PIEZAS ESPECIALES · SPECIAL PIECES · PIÈCES SPÉCIALES · СПЕЦИАЛЬНЫЕ ЭЛЕМЕНТЫ

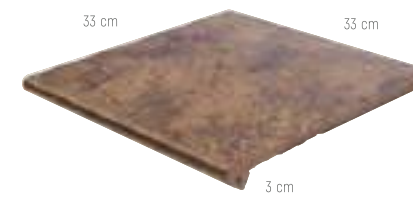

**PELDAÑO FIORENTINO**  
33 x 33 x 3 cm - 13.0" x 13.0" x 1.2"  
± 12 mm  
C-1



**CARTABÓN FIORENTINO**  
33 x 33 x 3 cm - 13.0" x 13.0" x 1.2"  
± 14 mm  
rectificado, rectified  
C-1



**ZANQUIN FIORENTINO IZDA./DCHA.**  
39,5 x 17,5 cm - 15.6" x 6.9"



**RODAPIÉ**  
9 x 33 cm - 3.6" x 13.0"  
± 11 mm



# METÁLICA / VULCANO

INDOOR: METÁLICA PURPLE 33x33 CM (C-1) - PELDAÑO FIORENTINO 33x33x3 CM







LUCCA

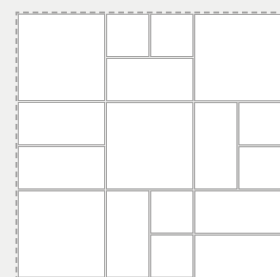

1 m<sup>2</sup>

33 x 33 cm	4 piezas. pieces
16,25 x 33 cm	7 piezas. pieces
16,25 x 16,25 cm	6 piezas. pieces



MANHATTAN

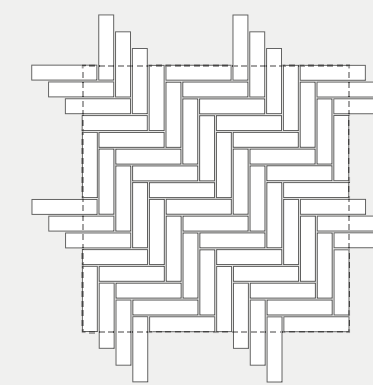

1 m<sup>2</sup>

5,75 x 24,5 cm | 76 uds/m<sup>2</sup>



ALHAMAR

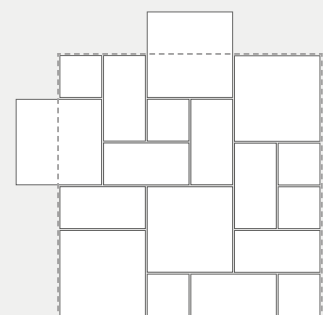

1 m<sup>2</sup>

33 x 33 cm	5 piezas. pieces
16,25 x 33 cm	7 piezas. pieces
16,25 x 16,25 cm	6 piezas. pieces

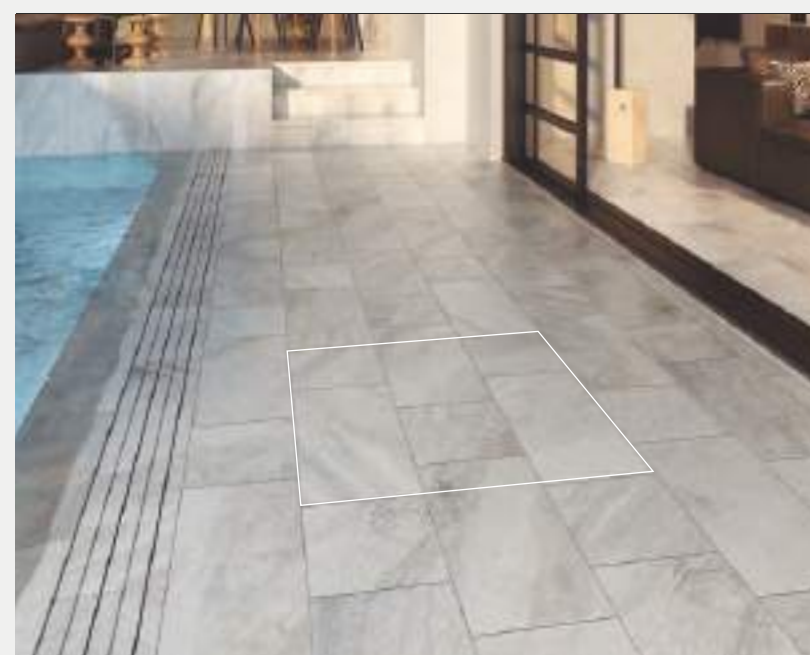

ROCA POLAR

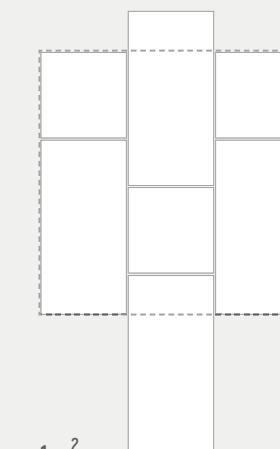

1 m<sup>2</sup>

33 x 66,5 cm	4 piezas. pieces
33 x 33 cm	3 piezas. pieces



Exagres se caracteriza por ofrecer una amplia gama de producto conformado mediante extrusión, con elevadas características técnicas, ideales tanto para el interior como el exterior de la vivienda, además de poderse dirigir a espacios públicos y privados.

Con el proceso de extrusión se consiguen piezas con determinadas geometrías y secciones complejas imposibles de alcanzar mediante el prensado, dando así soluciones completas para recubrimientos integrales y homogéneos con un mismo material cerámico.

Todo esto unido con la tecnología de impresión digital, que permite decorar con cualquier diseño la pieza cerámica por completo, desde los bajos relieves hasta los diferentes planos que ofrecen nuestras piezas, hace que Exagres pueda ofrecer un producto único y de calidad superior tanto técnica como estéticamente.

El objetivo principal de Exagres son los clientes, por ese motivo estamos al corriente de las últimas tendencias para poder ofrecer productos innovadores como soluciones en escalones de gran formato y piscinas.

Exagres is characterised by the wide range of products, shaped through extrusion, that it has on offer. These products have important technical characteristics, ideal for both inside and outside the home, as well as being suitable for both public and private spaces.

Through the extrusion process, pieces are obtained with certain geometries and complex sections that are impossible to achieve through compacting, thus providing complete solutions for integral and standardised cladding with the same ceramic material.

All of this, together with the digital printing technology which permits decoration on the entire ceramic piece with any design, from low relief to the various images offered by our pieces, means that Exagres can offer a unique product with superior quality both technically and aesthetically.

The principal objective of Exagres is our customers, therefore we stay up to date with the latest trends in order to be able to offer innovative products as solutions for large scale stairs and swimming pools.

La particularité d'Exagres est d'offrir une large gamme de produits mis en forme par extrusion, aux grandes caractéristiques techniques, idéales aussi bien pour l'intérieur que pour l'extérieur du logement, en plus de pouvoir s'adresser à des espaces publics et privés.

Grâce au procédé d'extrusion, il est possible d'obtenir des pièces aux géométries spécifiques et des sections complexes impossibles à atteindre par le pressage, apportant ainsi des solutions complètes pour des revêtements intégraux et homogènes avec un même matériau céramique.

Tout cela associé à la technologie d'impression numérique, qui permet de décorer entièrement avec n'importe quel design la pièce céramique, des bas-reliefs aux différents plans qu'offrent nos pièces, permet à Exagres d'offrir un produit unique et de qualité supérieure aussi bien technique qu'esthétique.

L'objectif principal d'Exagres sont les clients, pour cette raison nous suivons les dernières tendances afin de pouvoir offrir des produits innovants tels que des solutions pour le marché des piscines et des marches de grand format.

Компания Exagres предлагает широкий спектр продукции, изготовленной путем экструзии, с высокими техническими характеристиками, идеально подходящей как для внутренней, так и наружной отделки домов, в дополнение к тому, что она может использоваться для частных и общественных пространств.

С помощью процесса экструзии мы можем изготавливать изделия с заданными размерами и сложными формами, которые невозможно достичь путем прессования, что позволяет нам предлагать универсальные решения для комплексной и однородной отделки с одним и тем же видом керамического материала.

Все это в сочетании с технологией цифровой печати, которая позволяет наносить любые изображения на керамическую плитку, начиная от рельефных текстур и заканчивая различными цветовыми решениями выпускаемых нами изделий, позволяет компании Exagres предлагать уникальную высококачественную продукцию как с технической, так и эстетической точки зрения.

Основной задачей компании Exagres является удовлетворение потребностей клиентов, поэтому мы всегда следим за последними тенденциями с тем, чтобы предлагать инновационную продукцию как крупноформатные ступени и изделия для бассейнов.

## PELDAÑO FIORENTINO 33 x 33 x 3 cm

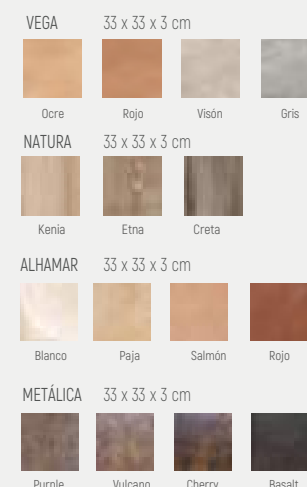

## CARTABÓN FIORENTINO 33 x 33 x 3 cm

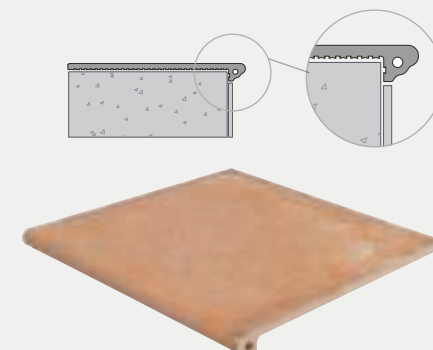
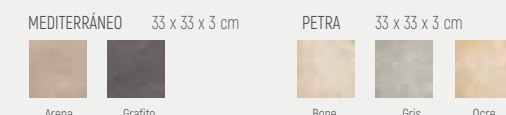

## PELDAÑO ML 24,5 x 33 x 4 cm / 33 x 33 x 4 cm

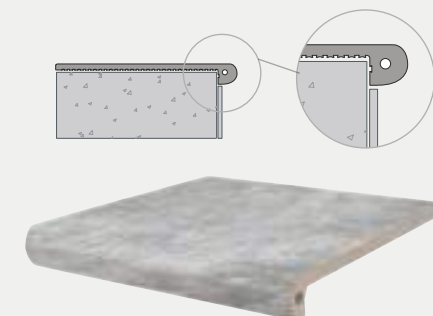
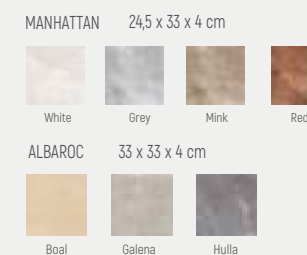

## PELDAÑO RECTO 33 x 33 x 3 cm

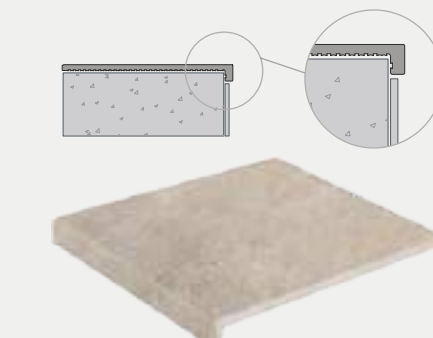

# PELDAÑOS 120 /

STEP 120 · MARCHE 120 · Ступень 120 см

# REMATE PELDAÑO 120 /

STEP 120 · MARCHE 120 · Ступень 120 см

El peldaño 120 es un avance como solución constructiva, que se adapta a las necesidades del mercado actual, evitando cortes y juntas.  
 Step 120 is an advance as a constructive solution, which adapts to the needs of the current market, avoiding cuts and joints.  
 La marche 120 représente un progrès comme solution de construction, qui s'adapte aux besoins du marché actuel, en évitant les coupures et les jointures.  
 Ступень 120 см является шагом вперед в качестве конструктивного решения, что отвечает потребностям современного рынка и позволяет предотвратить резку плитки и образование швов.

## PELDAÑO 120 RECTO 33 x 120 x 3 cm / 33 x 60 x 3 cm



<b>NUBIA</b> 33 x 120 x 3 cm  Nubia R9 R11 C-1 C-3	<b>IMPERIAL</b> 33 x 120 x 3 cm  Arian Ceniza Moca Siena R9 R11 C-1 C-3	<b>MARBLES</b> 33 x 120 x 3 cm - 33 x 60 x 3 cm  Calacatta Travertino Crema Marfil R11 C-3	<b>MARKINA</b> 33 x 120 x 3 cm  Bianco Nero R9 R11* C-1 C-3* <small>*sólo markina blanco</small>
<b>KIOTO</b> 33 x 120 x 3 cm  Roble Nogal Wengué R10 C-1	<b>MILÁN</b> 33 x 120 x 3 cm  Arena Gris Marengo R9 R12 C-1 C-3	<b>YOHO</b> 33 x 120 x 3 cm  Maple Natural Oak Teca R9 R11 C-1 C-3	
<b>LITOS</b> 33 x 120 x 3 cm  Ártico Sabana Siberia R12 C-3	<b>ALBAROC</b> 33 x 120 x 3 cm  Boal Galena Hulla R12 C-3	<b>ÓPERA</b> 33 x 120 x 3 cm  Ivory Light Silver Iron R9 R12 C-1 C-3	

## REMATE PELDAÑO RECTO 3 x 33 cm



<b>IMPERIAL</b> 3 x 33 cm  Arian Ceniza Moca Siena	<b>MARBLES</b> 3 x 33 cm  Calacatta Travertino Crema Marfil	<b>MARKINA</b> 3 x 33 cm  Bianco Nero
<b>YOHO</b> 3 x 33 cm  Maple Natural Oak Teca	<b>KIOTO</b> 3 x 33 cm  Roble Nogal Wengué	<b>LITOS</b> 3 x 33 cm  Ártico Sabana Siberia
<b>MILÁN</b> 3 x 33 cm  Arena Gris Marengo	<b>ÓPERA</b> 3 x 33 cm  Ivory Light Silver Iron	<b>ALBAROC</b> 3 x 33 cm  Boal Galena Hulla

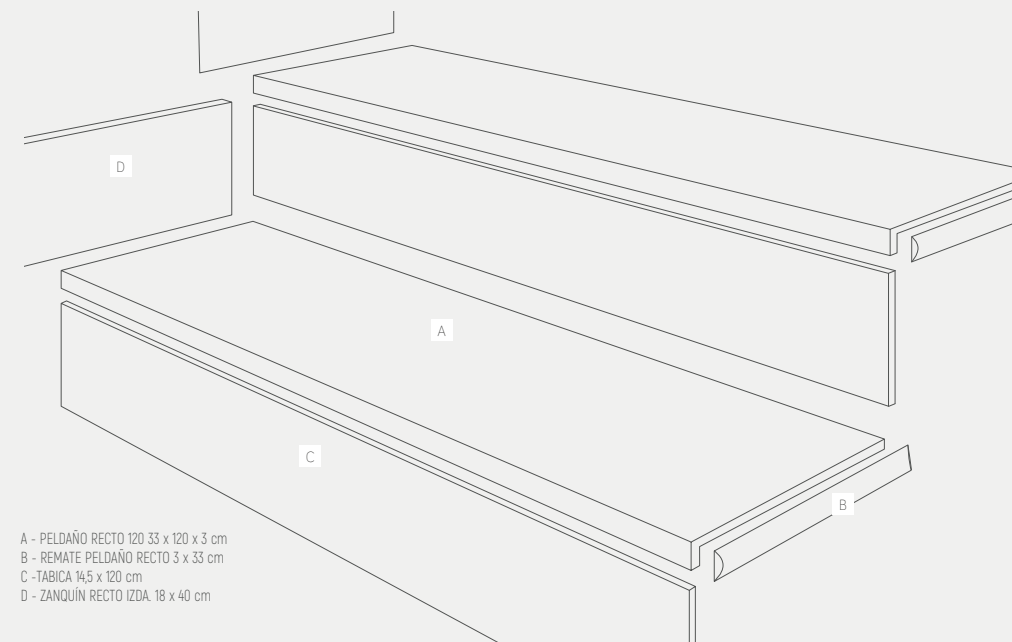

A - PELDAÑO RECTO 120 33 x 120 x 3 cm  
 B - REMATE PELDAÑO RECTO 3 x 33 cm  
 C - TABICA 14,5 x 120 cm  
 D - ZANQUIN RECTO IZDA. 18 x 40 cm



# PELDAÑOS 120 ML /

STEP 120 · MARCHE 120 · Ступень 120 см

PELDAÑO ML 120  
33 x 120 x 4 cm



PELDAÑO 120 FIORENTINO  
33 x 120 x 3 cm

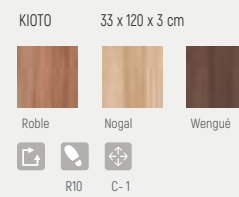

# REMATE PELDAÑO ML 120 /

STEP 120 · MARCHE 120 · Ступень 120 см

REMATE ML  
4 x 33 cm



REMATE PELDAÑO FIORENTINO DCHA./IZDA.  
3 x 33 cm

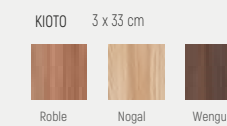
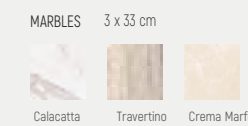

# ZANQUINES /

SKIRTING BOARD · PLINTHE · Лестничный плинтус

# ZANQUINES 18x40 /

SKIRTING BOARD · PLINTHE · Лестничный плинтус

ZANQUÍN FIORENTINO IZDA./DCHA.  
39,5 x 17,5 cm



<b>KIOTO</b> 39,5 x 17,5 cm	<b>NATURA</b> 39,5 x 17,5 cm
Roble Nogal Wengué	Kenia Etna Creta
<b>VEGA</b> 39,5 x 17,5 cm	<b>PETRA</b> 39,5 x 17,5 cm
Ocre Rojo Visón Gris	Bone Gris Ocre
<b>METÁLICA</b> 39,5 x 17,5 cm	<b>ALHAMAR</b> 39,5 x 17,5 cm
Purple Vulcano Cherry Basalt	Blanco Paja Salmón Rojo
	<b>MEDITERRÁNEO</b> 39,5 x 17,5 cm
	Arena Grafito

ZANQUÍN ML IZDA./DCHA.  
39,5 x 17,5 cm



<b>IMPERIAL</b> 39,5 x 17,5 cm	<b>OROBICO</b> 39,5 x 17,5 cm	<b>VENATTO</b> 39,5 x 17,5 cm
Arian Ceniza Moca Siena	Gris Taupe	Perla
<b>MANHATTAN</b> 39,5 x 17,5 cm	<b>ROCA</b> 39,5 x 17,5 cm	<b>LUCCA</b> 39,5 x 17,5 cm
White Grey Mink Red	Polar	Terra Grigio

ZANQUÍN RECTO IZDA./DCHA.  
42,3 x 17,5 cm



<b>IMPERIAL</b> 42,3 x 17,5 cm	<b>YOHO</b> 42,3 x 17,5 cm	
Arian Ceniza Moca Siena	Maple Natural Oak Teca	
<b>KIOTO</b> 42,3 x 17,5 cm	<b>MEDITERRÁNEO</b> 42,3 x 17,5 cm	<b>ROCA</b> 42,3 x 17,5 cm
Roble Nogal Wengué	Arena Grafito	Polar
<b>MILÁN</b> 42,3 x 17,5 cm	<b>ÓPERA</b> 42,3 x 17,5 cm	
Arena Gris Marengo	Ivory Light Silver Iron	

ZANQUÍN RECTO IZDA./DCHA.  
18 x 40 cm



<b>MARBLES</b> 18 x 40 cm	<b>MARKINA</b> 18 x 40 cm
Calacatta Travertino Crema Marfil	Bianco Nero
<b>LITOS</b> 18 x 40 cm	<b>ALBAROC</b> 18 x 40 cm
Ártico Sabana Siberia	Boal Galena Hulla

ZANQUÍN ML IZDA./DCHA.  
18 x 40 cm



<b>ALBAROC</b> 18 x 40 cm
Boal Galena Hulla

ZANQUÍN FIORENTINO IZDA./DCHA.  
18 x 40 cm



<b>MARBLES</b> 18 x 40 cm
Calacatta Travertino Crema Marfil

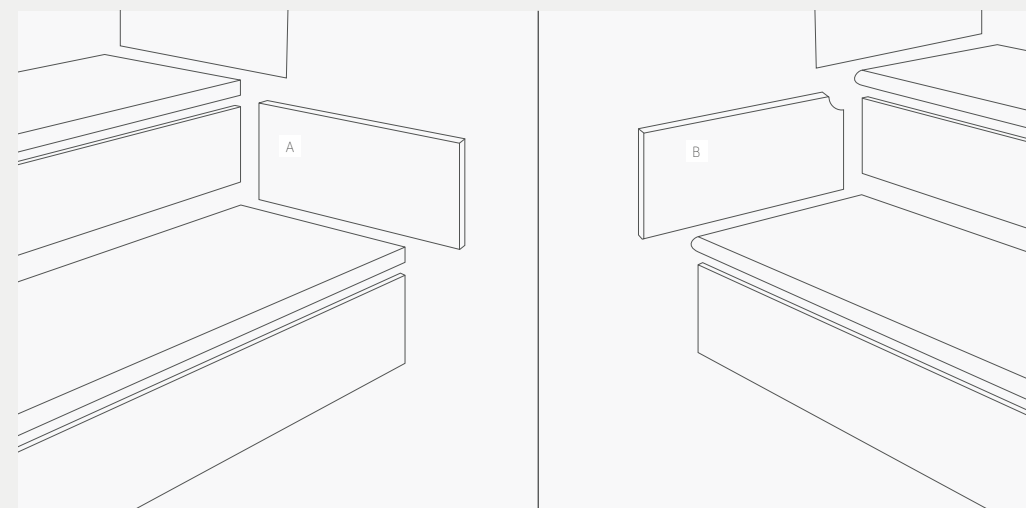

A - ZANQUÍN RECTO DCHA. 18 x 40 cm  
B - ZANQUÍN ML IZDA. 18 x 40 cm



## CORONACIÓN SKIMMER. SKIMMER SYSTEM

BORDE SKIMMER. 45x75x3 cm

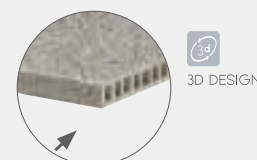

D. Continuidad gráfica, parte trasera.  
Graphic continuous, backside.

IMPERIAL

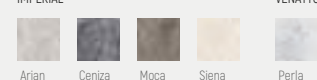

R11 C-3 CLASE C

VENATTO



R11 C-3 CLASE C

MILÁN

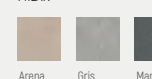

R12 C-3 CLASE C

ÓPERA

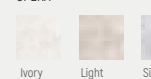

R12 C-3 CLASE C

YOHO

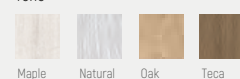

R11 C-3 CLASE C

BORDE PISCINA. 28 x 66,5 cm / 28 x 33 cm



ÁNGULO INTERIOR. 33x33 cm



ÁNGULO EXTERIOR. 28x28 cm

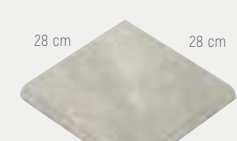

NATURA

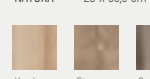

R11 C-3 CLASE C

PETRA

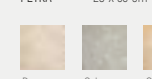

R12 C-3 CLASE C

LUCCA

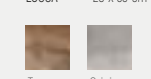

R11 C-3 CLASE C

BORDE PISCINA. PELDAÑO 120 RECTO.  
33 x 120 x 3 cm\* · 33 x 60 x 3 cm\*\*



PIEZAS VASO PISCINA

MEDIA CAÑA  
33 x 4 cm - r-3 cm

UÑA  
4 x 4 cm

NUBIA\* 33 x 120 x 3 cm



R11 C-3 CLASE C

MARBLES\*\* 33 x 120 x 3 cm / 33 x 60 x 3 cm

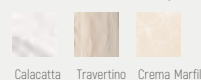

R11 C-3 CLASE C

ARISTA  
33 x 3 cm - r-3 cm

UÑA ARISTA  
3 x 3 cm

## CORONACIÓN DESBORDANTE. OVERFLOW SYSTEM

BORDE DESBORDANTE. 28x66,5 cm



ÁNGULO BORDE DESBORDANTE. 31x31 cm



REJILLA. 24,5 x 24,5 cm



ÁNGULOS REJILLA IZDA. DCHA.

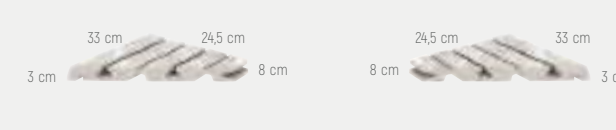

IMPERIAL

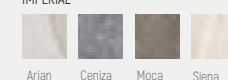

R11 CLASE C C-3

VENATTO



R11 CLASE C C-3

LITOS

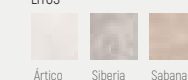

R12 CLASE C C-3

ROCA



R12 CLASE C C-3

ÓPERA

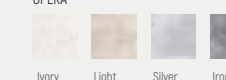

R12 CLASE C C-3

PIEZAS VASO PISCINA

MEDIA CAÑA  
33 x 4 cm - r-3 cm

ARISTA  
33 x 3 cm - r-3 cm

ÁNGULO EXTERIOR ARISTA\*  
5 x 5 cm

UÑA  
4 x 4 cm

UÑA ARISTA  
3 x 3 cm

ÁNGULO INTERIOR ARISTA\*  
5 x 5 cm

\*sólo series Imperial y Venatto

IMPERIAL

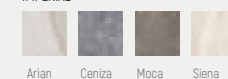

R11 CLASE C C-3

VENATTO



R11 CLASE C C-3

LITOS

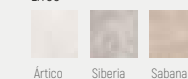

R12 CLASE C C-3

ROCA



R12 CLASE C C-3

ÓPERA

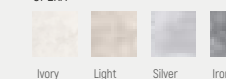

R12 CLASE C C-3

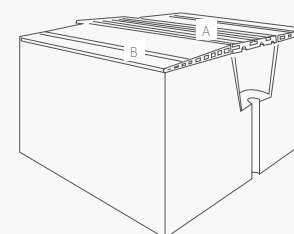

A - REJILLA 24,5 x 24,5 cm ( COLOCACIÓN ALTERNADA A 180° )  
B - BORDE DESBORDANTE 28 x 66,5 cm  
C - REJILLA 24,5 x 24,5 cm ( COLOCACIÓN ALTERNADA A 180° ), VISTA CENTAL

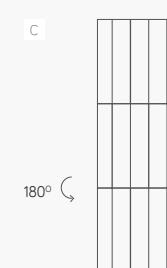

No rejuntar  
No pegar

Las rejillas cerámicas de Exagres deben colocarse sueltas, apoyadas y sin rejuntar, nunca pegadas.  
ingles, nocuterior audemptic iacchus conequis; num tu qua L. Etrae cul hiliunnum iam in vis rei inum etrae, C. Um et aliame  
francés, sam quuntio ruptat re modipsam eturerum si connihil incto dolore et vendia nusam con conem nonsectaecto erroribus ut eni utenimus voluptat re  
ruso, Ступень 120 см является шагом вперед в качестве конструктивного решения, что отвечает потребностям современного рынка и позволяет

# VIERTEAGUAS /

WINDOW SILLS · APPUIE DE FENÊTRE · Подоконник

VIERTEAGUAS. 15 x 24,5 x 4 cm / 12 x 33 x 3 cm / 15 x 33 x 4 cm\*

## DESCRIPCIÓN · DESCRIPTION · DESCRIPTION · ОПИСАНИЕ

- Forma rectangular con borde lateral redondeado provisto de goterón. Superficie inferior ranurada en cola de milano para optimizar el agarre al soporte.
- Rectangle shape with lateral rounded edge provided with big drop. Back tile in dove tail profile to improve the hold to the stab.
- Format rectangulaire, le bord latérale arrondi avec dispositif anti-goute. La surface inférieure fendue en queue d'aronde pour optimiser l'adhérence de l'appui.
- Элементы имеют прямоугольную форму с одним закругленным краем для облегчения дренажа. Обратная сторона элементов выполнена в форме сечения "ласточкин хвост" для надежной фиксации элемента.

## APLICACIONES Y COLOCACIÓN · APPLICATIONS AND INSTALLATION · APPLICATIONS ET POSE · ПРИМЕНЕНИЕ И МОНТАЖ

- Vierendeaguas en ventanas, marquesinas, voladizos, repisas, remate superior de muros medianeros, perimetrales y cercas.
- Window Sills in windows, porches, projecting, brackets, top finishing for diving walls, perimeter walls and fences.
- Appuie pour les fenêtres, marquises, rebords, finition supérieur de murs mitoyens, des clôtures, etc.
- Данная плита укладывается как подоконник, так же подходит для отделки террас, изгородей, а так же как наружная облицовка.



### MANHATTAN 15 x 24,5 x 4 cm

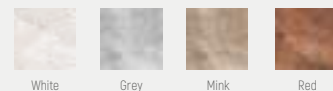

### MEDITERRÁNEO 12 x 33 x 3 cm

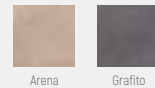

### VEGA 12 x 33 x 3 cm

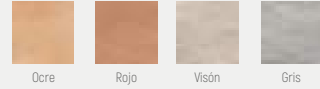

### LUCCA 15 x 33 x 4 cm

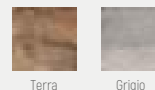

### ALHAMAR 15 x 33 x 4 cm

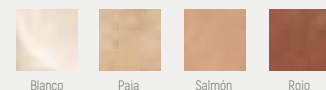

# PASAMANOS /

HANDDRAILS MAIN COURANT · COUVRE MURS · ПОРУЧНИ

PASAMANOS. 12,5 x 66,5 x 4 cm / 15,5 x 66,5 x 4 cm

\*medidas interiores. inner measures.

## DESCRIPCIÓN · DESCRIPTION · DESCRIPTION · ОПИСАНИЕ

- Forma rectangular con bordes laterales redondeados provistos de goterón, la parte superior dispone de una ligera curvatura que facilita el drenaje. Superficie interior ranurada en cola de milano para optimizar el agarre al soporte.
- Rectangle shape with lateral rounded edges provided with big drop, the top side has a slight curvature (bend) to ease the drainage. Back tile in dove tail profile to improve the hold to the stab.
- Format rectangulaire, les bords latérales arrondis avec dispositif anti-goute, la partie supérieure dispose d'une très légère courbature pour faciliter le drainage. Superficie intérieur rainurer pour faciliter la pose sur tous types de support.
- Элементы имеют прямоугольную форму с закругленными краями по углам, верхняя сторона имеет небольшой изгиб для облегчения дренажа. Обратная сторона элементов выполнена в форме сечения "ласточкин хвост" для надежной фиксации элемента.

## APLICACIONES Y COLOCACIÓN · APPLICATIONS AND INSTALLATION · APPLICATIONS ET POSE · ПРИМЕНЕНИЕ И МОНТАЖ

- Cubremuros, antepechos de terrazas, azoteas, tendederos, escaleras, pretils y coronación de cercas y muros divisorios.
- Top-wall finishing, terrace parapets, flat roofs, drying places, stairs, handrails and tops for fences and dividing walls.
- Main courante, couvre-murs, finition de murs verticales, etc.
- Используется в качестве поручней и перил лестниц. Может применяться для финишной отделки парапетов террас, плоских крыш, верхнего облицовочного элемента стенок, перегородок и т.д.



### MEDITERRÁNEO

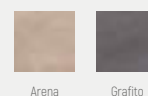

### ALBAROC

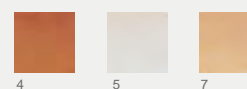
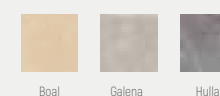



## RECOMENDACIONES DE COLOCACIÓN

Las Series de EXAGRES, S.A. están fabricadas en gres extrusionado de baja absorción de agua, bajo la norma de producto UNE-EN 14411 Grupo Alb. Aunque el dorso de las piezas está estriado en cola de milano para aumentar la adhesión de las mismas al mortero de agarre, EXAGRES recomienda, sin excluir otros posibles métodos, la colocación de baldosas y piezas especiales con mortero adhesivo predosificado (tipo cemento-cola) de buena calidad adecuado al uso y condiciones de uso del recubrimiento cerámico. En zona de climatología severa, riesgo de heladas o colocación en exteriores o piscinas, se recomienda utilizar morteros adhesivos "tipo flexible", "especial porcelánico", "especial fachadas" o "especial piscinas" en cada caso, de un fabricante reconocido de materiales de instalación de cerámica, disponible en almacenes de materiales.

## SOPORTE DE COLOCACIÓN

Deberá ser estable dimensionalmente, sano, sólido, resistente y rígido, con superficie de rugosidad suficiente. Soportes flexibles o estructuras deformables requieren una capa de desolidarización y juntas de movimiento, formatos menores y juntas de colocación más anchas.

## COLOCACIÓN EN CAPA GRUESA

En caso de utilizar el sistema tradicional, recomendamos usar morteros de capa gruesa mejorados con aditivo látex para aumentar la adhesión de la capa de agarre con la cerámica de baja absorción. Existen morteros adhesivos preparados de capa media que permiten nivelar (hasta 2-3 cm.) e instalar la cerámica a la vez.

## COLOCACIÓN EN CAPA FINA

Previamente hay que regularizar el soporte con una capa de mortero de nivelación. Sobre el soporte nivelado se extiende el mortero adhesivo en capa fina (TIPO C2 según norma UNE EN 12004:01), en lecho continuo, con llana dentada de tamaño adecuado. En solados exteriores se resolverán cuidadosamente las pendientes de desagüe, la impermeabilización del soporte y la confección de juntas perimetrales y juntas de partición cada 5x5 m. como máximo. La junta entre las piezas recomendada será de 5 mm, para respetar la modularidad de las series y la correspondencia de juntas entre los diferentes formatos y/o piezas especiales. IMPORTANTE: se respetará la dirección del ranurado posterior de las baldosas, colocándolas siempre en la misma dirección.

## REJUNTADO

El rejuntado se efectuará con un material de prestaciones adecuadas a la solicitud del recubrimiento durante su uso, y se optará por un mortero preparado de cualquier fabricante reconocido, ya que ofrecen una amplia gama de colores y materiales de diferentes características. El tipo de mortero de juntas adecuado será Tipo CG2 (según UNE EN 13888) usando , en caso de requerir resistencia química materiales Tipo RG.

## ASESORAMIENTO

Es conveniente contar con el asesoramiento del fabricante de materiales de instalación elegido, para que facilite información sobre prestaciones, instrucciones de uso, tiempo abierto, etc. así como procedimientos de limpieza de la instalación después de la colocación y el rejuntado.

## TAREAS PREVIAS A LA COLOCACIÓN

Las baldosas se mezclarán antes de su colocación para conseguir una destonificación armónica, abriendo varias cajas de diferentes pallets, en su caso.

## LIMPIEZA DE OBRA Y MANTENIMIENTO

Si después de la colocación y la primera limpieza, quedan restos de materiales cementosos sobre la superficie de la instalación, usar un limpiador cerámico o desincrustante ácido adquirido en cualquier almacén de materiales. Antes de la aplicación mojar el recubrimiento para saturar las juntas de agua y protegerlas de la acción del limpiador. Después del lavado, eliminar el producto con abundante agua limpia. Para el mantenimiento ordinario, existen productos adecuados específicos para cerámica.

## PAVIMENTOS EXTERIORES

Los pavimentos exteriores se encuentran sometidos continuamente a duras condiciones atmosféricas y a la acción de heladas y choque térmicos, que pueden provocar daños irreparables en la instalación. Por ello se extremará el control de ejecución y la calidad de los materiales empleados. Se asegurará la estanqueidad de la instalación para evitar filtraciones de agua al soporte y se resolverá cuidadosamente el sellado de las juntas, entre piezas, perimetrales y de dilatación. Las juntas de dilatación y partición atravesarán el solado, la capa de agarre y la de nivelación.

## RECLAMACIONES

La legislación actual requiere que las demandas sean presentadas antes de la colocación de las baldosas. De modo que no se considerarán reclamaciones sobre materiales ya colocados.

## INSTALLATION SUGGESTIONS

EXAGRES, S.A. Series is a glazed and very low water absorption extruded ceramic, product norm EN 14411 Alb Group. Although the back tiles profiled in dove tail to increase the adherence to the setting mortar, EXAGRES recommend, without excluding any other possible systems, installing the tiles and special pieces with a thin set mortar method. In outdoor places with a hard cold weather, risk of freeze or when placing in exterior wall, the use of "flexible thin set mortar" is recommended, "special porcelanic tile" or "high strength mortar" from a known manufacturer of ceramic tile installation materials, available in any building materials warehouse or tiles dealer.

## INSTALLATION SLAB

Must be clean, dry, structurally sound and ensure the rough surface. A cleavage membrane is necessary in concrete slabs with a deflection and building structures with a movement. Small sizes tiles, wide joints between tiles and movement joints are recommended.

## THICK BED METHOD

In that case, use cement mortars with latex admix, for improved bond to the very low absorption tiles. You can use medium thickness bed mortars for leveling and installing.

## THIN BED METHOD

The installation system, over clean, dry structurally sound and free from any bond breaking surface, consist in placing a thin bond coat (C2 Type EN 12004:01 norm), extended continuously with notched trowel. In exteriors the water draining slopes will be carefully resolved, as well the waterproofing slab and the placing perimeter joints and expansion joints every 5x5 m. The recommended joint between pieces will be 5 mm, to respect modularity and the correspondance of joints between different sizes and/or specials pieces. VERY IMPORTANT we recommend setting the pieces with the back grooved in the same direction.

## GROUTING

The grouting will be done by a grout that adequates its characteristics to the coating and the use of installation, choosing any grout from any known manufacturer, whose range of colours and materials are usually wider. Grout must be CG2 Type (EN 13888 norm) using grout RG Type (epoxy grout) for best chemical and stain resistance.

## TECHNICAL SUPPORT

It is recommended to be advice by the chosen manufacturer in order to be technical supported about characteristics, instructions of use, open time, etc. as well as cleaning tips after installing tiles.

## PREVIOUS TASKS BEFORE INSTALLATION

Before laying the tiles, mix them from several boxes and pallets, in order to ensure a uniform look and the best result.

## CLEANING AND MAINTENANCE

After the installation and the first cleaning, remove the cured grout with a commercial ceramic cleaner, or acid remover from any ceramic tile installation products manufacturer. Follow the instructions of use from manufacturer. Use specific ceramic cleaners in the maintenance tasks.

## EXTERIORS FLOORS

Exterior floors are submitted to several requirements and weather conditions, frost, thermal shocks, etc. which are able to cause damages. It is essential to check the masonry works, installation method and quality of tiling materials.

Appropriate slopes, waterproofing, expansion and perimeter joints, grouting and sealing the joints, are fundamental.

## COMPLAINTS

Note that current legislation requires disputes to be before installation tiles. Complaints concerning already laid materials shall not, therefore, be proposed and shall not be considered.

## RECOMMANDATIONS POUR LA POSE

Les séries d'EXAGRES S.A. ont été fabriquées en gres étiré. Ce carreaux ont une absorption d'eau basse selon la norme EN 14411 Groupe Alb. Bien que la queue d'aronde du dos des carreaux serve à mieux les adhérer au mortier, Exagres conseille de placer les carreaux et pièces spéciales à l'aide d'un mortier adhésif prédosé (genre ciment-colle) de bonne qualité et approprié aux possibles domaines d'application des carreaux.

## SUPPORT

Le support doit être solide, résistant, rigide et suffisamment rugueux. Les supports souples ou les structures déformables ont besoin d'une couche de désolidarisation; des joints de mouvement, des formats plus petits, ainsi que des joints plus larges.

## POSE EN COUCHE ÉPAISSE

En ce qui concerne le système traditionnel, nous recommandons l'utilisation de mortiers à couche épaisse améliorés à base d'additif latex afin d'augmenter l'adhésion de la couche d'adhérence avec la céramique à absorption basse. Il existe des mortiers adhésifs à couche moyenne déjà préparés qui permettent de niveler (jusqu'à 2-3 cm) et installer les carreaux au même temps.

## POSE EN COUCHE MINCE

Premièrement il faut régulariser le support à l'aide d'une couche de mortier de nivellement. Sur le support nivelé il faut étendre le mortier adhésif en couche mince (TYPE C2 selon UNE EN 12004 :01) et continueuse avec une truelle dentée. Quant aux surfaces extérieures il faut faire attention aux pentes de drainage, à l'imperméabilisation du support. Nous recommandons faire des joints de dilatation tous les 5x5 m au maximum. Les joints entre les carreaux doivent avoir une largeur de 5 mm afin de respecter la modularité des différentes séries.

ATTENTION: il est conseillé de poser les carreaux de façon à ce que la queue d'aronde suive toujours la même direction.

## JOINTELEMENT

Il est conseillé d'effectuer le jointement avec du matériel approprié au domaine possible d'application des carreaux, en choisissant un mortier d'un fabricant spécialisé, puisqu'ils offrent un grand choix de couleurs et matériaux. Le mortier pour joints le plus approprié est celui de Type CG2 (selon UNE EN 13888). Nous recommandons le matériel du Type RG pour obtenir une résistance aux produits chimiques complémentaire.

SUGGESTION: Il est recommandable de se faire conseiller par le fabricant du matériel choisi par rapport aux caractéristiques, mode d'emploi, temps d'ouverture. Également il peut vous conseiller sur le nettoyage du sol après la pose des carreaux.

## RECOMMANDATIONS AVANT LA POSE

Pour que la surface totale de carrelage ait une détonification harmonique, nous conseillons de mélanger des carreaux de différentes boîtes.

## NETTOYAGE ET ENTRETIEN

Dans le cas où il resterait des traits de mortier sur la surface d'installation, il faudrait utiliser un produit spécifique pour la céramique ou, autrement, un produit désincrustant. Premièrement il est conseillé de mouiller la surface à nettoyer avec l'objectif de remplir les joints d'eau et les protéger de l'action du produit nettoyant. Une fois le nettoyant appliqué, il faut rincer avec de l'eau propre. Pour ce qui concerne l'entretien ordinaire, il existe des produits spécifiques pour la céramique.

## REVÊTEMENTS À L'EXTÉRIEUR

Les carreaux posés à l'extérieur peuvent souffrir les effets des chocs thermiques, des gelées, etc, ce qui peut endommager l'installation. De ce fait il faut absolument faire attention aux travaux de pose du carrelage, ainsi qu'à la qualité des matériaux y utilisés. Il faut éviter les filtrations d'eau dans le support. Il faut également faire attention à bien sceller tous les joints.

## RÉCLAMATIONS

Selon la loi actuelle aucune réclamation ne sera prise en compte après la pose des carreaux céramiques. Une fois les carreaux placés, les réclamations ne seront pas prises en compte.

## РЕКОМЕНДАЦИИ ПО УКЛАДКЕ КЕРАМИЧЕСКОЙ ПЛИТКИ И СПЕЦИАЛЬНЫХ ЭЛЕМЕНТОВ EXAGRES

Все коллекции фабрики EXAGRES, S.A. произведены по технологии экструдированного клинкера. Керамическая плитка и элементы EXAGRES имеют низкое водопоглощение в соответствии с нормативом EN 14411 Группа Alb.

## ОБЩИЕ РЕКОМЕНДАЦИИ

Технология подготовки оснований и укладки керамической плитки, а также специальных элементов должна соответствовать строительным правилам и нормам вашего региона.

При использовании материалов необходимо тщательно следовать рекомендациям и правилам применения Производителей данных материалов

## НАПОЛЬНАЯ ПЛИТКА ДЛЯ НАРУЖНОГО ПРИМЕНЕНИЯ

Внешние покрытия всегда подвергаются воздействию погодных условий, мороза, перепадов температуры, что может послужить причиной деформации укладки. Поэтому, рекомендуем Вам контролировать процесс укладки и качество используемых материалов и растворов. Основание должно быть должным образом усилено арматурой и гидроизолировано, чтобы избежать протечек воды. Рекомендуется хорошо заполнять швы между плитками, компенсационные швы и швы по периметру, примыкающие к стенам здания. Компенсационные швы должны полностью пересекать все основание.

## ОСНОВАНИЕ, НА КОТОРУЮ БУДЕТ УКЛАДЫВАТЬСЯ ПЛИТКА

Основание, на которую будет укладываться плитка должна быть идеально ровное, прочное, устойчивое и твердое. Поверхность основания должна быть достаточно шероховатой.

При необходимости, при наружных работах, основание должно быть гидроизолировано.

Плитка и ступени на наружных площадках и лестницах должны быть уложены под определенным углом, для избегания застоя воды

## КЛЕЕВЫЕ СМЕСИ

EXAGRES рекомендует, укладывать облицовочную плитку с использованием качественных клеевых цементных смесей, отвечающим требованиям эксплуатации плитки.

Для укладки плитки в бассейнах, в местах с контрастным климатом, а также при наружных работах, рекомендуется использовать профессиональные клеевые смеси, пригодные для реальных условий эксплуатации, например:

- специальный для наружных работ
- специальный для керамогранита
- специальный для фасадов
- специальный для бассейнов
- специальный для клинкера

Клеевые смеси, которые будут использоваться для укладки плитки EXAGRES, должны быть пригодны для приклеивания плитки с низким коэффициентом водопоглощения, согласно рекомендациям производителя клеевой смеси

## УКЛАДКА В ТОЛСТОМ СЛОЕ

При укладке плитки с одновременным выравниванием основания, а также при толщине плиточного клея до 2-3 см, рекомендуется специальный клей для толстого слоя с латексными добавками.

## УКЛАДКА В ТОНКОМ СЛОЕ

Прежде чем наносить слой клея, требуется выровнять основание.

Клеевая смесь наносится зубчатым шпателем на ровное основание тонким слоем

## УКЛАДКА ПЛИТКИ

EXAGRES рекомендует перед укладкой плитки и ступеней, вынуть ее из всех коробок и тщательно перемешать между собой, для того чтобы достичь гармоничной разнотонности.

Укладка плитки осуществляется по направлению полос, которые находятся на задней стороне плитки и элементов

## КОМПЕНСАЦИОННЫЙ ШОВ РАСШИРЕНИЯ

При укладке плитки на подвижные основания, которые могут деформироваться в процессе эксплуатации требуется предусмотреть компенсационный шов расширения между рядами плитки. Компенсационный шов расширения рекомендуется делать каждые 5x5 м, а также в местах примыкания площадок к стенам зданий. Ширина шва должна быть не меньше 5 мм. Шов расширения должен быть заполнен эластичным наполнителем.

## ЗАТИРКА

Затирочный раствор для швов, выбирается в зависимости от условий дальнейшей эксплуатации напольной поверхности. При укладке снаружи затирка может быть сделана влагостойкой с помощью специальных добавок.

## ОКОНЧАТЕЛЬНАЯ ЧИСТКА И УХОД

После укладки плитки для удаления цементного налета рекомендуется использовать специальное средство для снятия налета, которые имеются у поставщиков клеевой смеси.

Перед использованием средства для удаления налета необходимо намочить швы водой, для того, чтобы их защитить.

После очистки требуется окончательно смыть средство водой из шланга или аппарата высокого давления

Для регулярной чистки рекомендуется использование подходящего для керамики средства.



La **extrusión** es una técnica de conformado para la fabricación de productos cerámicos. Básicamente el proceso de extrusión consiste en forzar el paso, mediante la aplicación de presión, de la pasta con consistencia plástica a través de una matriz. La fabricación de baldosas mediante el proceso de extrusión consta de cuatro fases principales: amasado, conformado, secado y cocción.

- el amasado consiste en el mezclado con agua de las materias primas previamente preparadas y molidas. Con esto se consigue una pasta fácilmente moldeable por extrusión.

- en el conformado se realiza introduciendo la masa plástica en la extrusora, y con presión de vacío es amasada y empujada a través de la boquilla para obtener las piezas finales. Con este proceso se pueden obtener piezas especiales como peldaños o bordes piscinas, etc...

- después las piezas ya moldeadas son sometidas a aire caliente para eliminar el contenido de humedad.

- posteriormente son cocidas a altas temperaturas, obteniendo una perfecta vitrificación de las mismas.

Con este proceso los materiales pueden ser reciclados en su totalidad y admiten hasta un 45% de materiales reciclados en su proceso estándar.

**Extrusion** is a shaping technique for the manufacture of ceramic products. Basically, the extrusion process consists of forcing the passage, through the use of pressure, of a paste with plastic consistency through a grid. The manufacture of tiles through the extrusion process consists of four main phases: kneading, shaping, drying and firing.

- The kneading consists of mixing the previously prepared and milled raw materials with water. This results in a paste that is easily malleable by extrusion.

- The shaping is carried out by placing the plastic paste in the extruder, which is kneaded and pushed through the nozzle by vacuum pressure in order to obtain the final pieces. This process results in special pieces such as steps or pool edging, etc.

- Later, the moulded pieces are subjected to hot air in order to eliminate any humidity.

- They are then fired at high temperatures, obtaining perfect vitrification of the same.

With this process, the materials can be fully recycled and accept up to 45% of recycled material in their standard process.

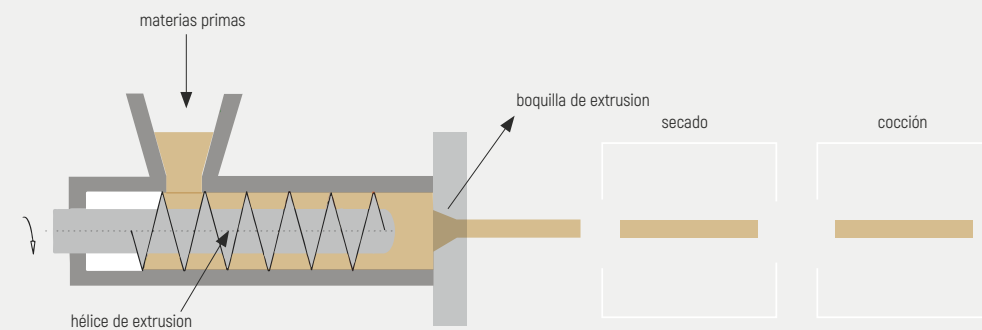

PROCESO DE EXTRUSIÓN - EXTRUSION PROCESS

L'extrusion est une technique de mise en forme pour la fabrication de produits en céramique. Le procédé d'extrusion consiste essentiellement à forcer le passage, à travers l'application d'une pression, de la pâte à consistance plastique à travers une matrice.

La fabrication de carreaux par le procédé d'extrusion se compose de quatre phases principales : malaxage, mise en forme, séchage et cuisson.

- le malaxage consiste à mélanger avec de l'eau les matières premières qui ont été préalablement préparées et moulues. Grâce à cela, on obtient une pâte que l'on peut facilement mouler par extrusion.

- la mise en forme se réalise en introduisant la pâte plastique dans une machine à extrusion. Cette pâte, sous la pression du vide, est malaxée et poussée à travers une filière pour obtenir les pièces finales.

Grâce à ce procédé, il est possible d'obtenir des pièces spéciales comme des marches ou des margelles de piscines, etc.

- ensuite, les pièces déjà moulues sont passées à l'air chaud afin d'éliminer le contenu d'humidité.

- puis, elles sont cuites à hautes températures, ce qui permet d'obtenir de ces dernières une parfaite vitrification.

Grâce à ce procédé, les matériaux peuvent être recyclés dans leur totalité et permettent jusqu'à 45 % de matériaux recyclés dans leur procédé standard.

Экструзия – технология, используемая для формовки керамических изделий при их изготовлении. В основном процесс экструзии заключается в продавливании под давлением пастообразного сырья через формирующее отверстие.

Производство керамической плитки с помощью экструзии состоит из четырех основных этапов: замеса, формовки, сушки и обжига.

- Замес заключается в смешивании с водой предварительно подготовленного и измельченного сырья. Конечным результатом этого процесса является легко поддающаяся обработке паста для экструзии.

- Формовка представляет собой загрузку полученной при замесе пасты в экструдер, в котором она перемешивается под вакуумным давлением и проталкивается через сопло для формовки конечных изделий.

С помощью этого процесса можно получить специальные изделия, такие как ступени или бордюры для бассейнов и т. д.

- После этого, уже сформованные изделия проходят обработку горячим воздухом для удаления влаги.

- Затем они подвергаются высокотемпературному обжигу до достижения ими необходимой витрификации (стеклования).

С помощью этого процесса материалы могут быть полностью переработаны. В стандартном процессе допускается использование до 45 % переработанных материалов.

## EL VALOR DE LA EXTRUSIÓN

THE VALUE OF EXTRUSION · LA VALEUR DE L'EXTRUSION · Преимущества экструзии

Las materias primas seleccionadas y el cuidado proceso de producción con las tecnologías más avanzadas y la labor de nuestro equipo humano, hacen que el producto obtenido posea unas características técnicas excepcionales. Con este proceso se pueden obtener geometrías tridimensionales en las piezas, imposibles de conseguir con el proceso de prensado tradicional.

The raw materials selected, the careful production process with the most advanced technologies, and the work of our human team mean that the product obtained has exceptional technical characteristics. With this process, three-dimensional geometries can be obtained on the pieces which are impossible to achieve with the traditional compacting process.

Les matières premières choisies, le rigoureux procédé de production qui utilise les technologies les plus avancées, ainsi que le travail de notre équipe humaine font que le produit obtenu possède des caractéristiques techniques exceptionnelles. Grâce à ce procédé, on peut obtenir des géométries tridimensionnelles sur les pièces, impossibles à réaliser avec le procédé de pressage traditionnel.

Благодаря отборному сырью и тщательному процессу производства с использованием самых передовых технологий и работе нашего коллектива полученные изделия обладают исключительными техническими характеристиками. Этот процесс позволяет изготавливать трехмерные изделия, что невозможно при использовании традиционного процесса прессования.





**Gres extruido de pasta blanca de baja absorción de agua, según UNE-EN 14411, grupo Alb, esmaltado.**  
White body extruded stoneware with low water absorption, according to EN 14411, group Alb, glazed.







COLECCIÓN	ABSORCIÓN DE AGUA WATER ABSORPTION ABSORPTION D'EAU ВОДОПОГЛОЩЕНИЕ	RESISTENCIA A LA FLEXIÓN MODULUS OF RUPTUR RÉSISTANCE À LA FLEXION СОПРОТИВЛЕНИЕ НА ИЗГИБ	RESISTENCIA A LA ABRASIÓN (PEI) DEEP ABRASION RESISTANCE RÉSISTANCE À L'ABRASION СТОЙКОСТЬ К ИСТИРАНИЮ ПОВЕРХНОСТИ	RESISTENCIA AL CHOQUE TÉRMICO THERMAL SHOCK RESISTANCE RÉSIST. AUX VARIATIONS THERMIQUES СТОЙКОСТЬ К ТЕПЛОВЫМ ПЕРЕПАДАМ	RESISTENCIA AL CUARTEO CRACKING RESISTANCE RÉSISTANCE AU TRESSAILLAGE УСТОЙЧИВОСТЬ К РАСТРЕКИВАНИЮ
	ISO 10545-3	ISO 10545-4	ISO 10545-7	ISO 10545-9	ISO 10545-11
NUBIA	< 1,5%	>30 N/mm <sup>2</sup> >1800 N	4	garantizado guaranteed garanti Гарантированно	garantizado guaranteed garanti Гарантированно
IMPERIAL	< 1,5%	>30 N/mm <sup>2</sup> >1800 N	4	garantizado guaranteed garanti Гарантированно	garantizado guaranteed garanti Гарантированно
OROBICO	< 1,5%	>30 N/mm <sup>2</sup> >1800 N	4	garantizado guaranteed garanti Гарантированно	garantizado guaranteed garanti Гарантированно
VENATTO	< 1,5%	>30 N/mm <sup>2</sup> >1800 N	4	garantizado guaranteed garanti Гарантированно	garantizado guaranteed garanti Гарантированно
MARKINA	< 1,5%	>30 N/mm <sup>2</sup> >1800 N	5 bianco 1 nero	garantizado guaranteed garanti Гарантированно	garantizado guaranteed garanti Гарантированно
MARBLES	< 1,5%	>30 N/mm <sup>2</sup> >1800 N	5	garantizado guaranteed garanti Гарантированно	garantizado guaranteed garanti Гарантированно
YOHO	< 1,5%	>30 N/mm <sup>2</sup> >1800 N	5	garantizado guaranteed garanti Гарантированно	garantizado guaranteed garanti Гарантированно
KIOTO	< 1,5%	>30 N/mm <sup>2</sup> >1800 N	4	garantizado guaranteed garanti Гарантированно	garantizado guaranteed garanti Гарантированно
NATURA	< 1,5%	>30 N/mm <sup>2</sup> >1800 N	4	garantizado guaranteed garanti Гарантированно	garantizado guaranteed garanti Гарантированно

RESISTENCIA A LA HELADA FROST RESISTANCE RÉSISTANCE AU GEL МОРОЗОСТОЙКОСТЬ	RESISTENCIA A LOS AGENTES QUÍMICOS CHEMICAL RESISTANCE RÉSISTANCE AUX PRODUITS CHIMIQUES СТОЙКОСТЬ К ВОЗДЕЙСТВИЮ ХИМИКАТОВ	RESISTENCIA A LAS MANCHAS STAIN RESISTANCE RÉSISTANCE AUX TACHES УСТОЙЧИВОСТЬ К ОБРАЗОВАНИЮ ПЯТЕН	RESISTENCIA AL DESLIZAMIENTO (rampa pie calzado) ANTI-SLIP RESISTANCE [ramp] RÉSISTANCE AU GLISSEMENT [piéd chaussé] СОПРОТИВЛЕНИЕ СКОЛЬЖЕНИЮ (если ходит обутым)	RESISTENCIA AL DESLIZAMIENTO (C.T.E.) ANTI-SLIP RESISTANCE RÉSISTANCE AU GLISSEMENT [C.T.E.] СОПРОТИВЛЕНИЕ СКОЛЬЖЕНИЮ (C.T.E.)	RESISTENCIA AL DESLIZAMIENTO (pie descalzo) ANTI-SLIP RESISTANCE [bare foot] RÉSISTANCE AU GLISSEMENT [piéd nu] СОПРОТИВЛЕНИЕ СКОЛЬЖЕНИЮ (босые ноги)
ISO 10545-12	ISO 10545-13	ISO 10545-14	DIN 51130	UNE 41901 EX	DIN 51097
garantizado guaranteed garanti Гарантированно	A - LA - HA	CLASE 5	R9 normal R11 anti-slip	CLASE 1 normal CLASE 3 anti-slip	- CLASE C anti-slip
garantizado guaranteed garanti Гарантированно	A - LA - HA	CLASE 5	R9 normal R11 anti-slip	CLASE 1 normal CLASE 3 anti-slip	- CLASE C anti-slip
garantizado guaranteed garanti Гарантированно	A - LA - HA	CLASE 5		CLASE 1	
garantizado guaranteed garanti Гарантированно	A - LA - HA	CLASE 5	R9 normal R11 anti-slip	CLASE 1 normal CLASE 3 anti-slip	- CLASE C anti-slip
garantizado guaranteed garanti Гарантированно	A - LA - HA	CLASE 5	R9 normal R11 anti-slip	CLASE 1 normal CLASE 3 anti-slip	- -
garantizado guaranteed garanti Гарантированно	A - LA - HA	CLASE 5	R9 normal R11 anti-slip	CLASE 1 normal CLASE 3 anti-slip	- CLASE C
garantizado guaranteed garanti Гарантированно	A - LA - HA	CLASE 5	R9 normal R11 anti-slip	CLASE 1 normal CLASE 3 anti-slip	- CLASE C
garantizado guaranteed garanti Гарантированно	A - LA - HA	CLASE 5	R10	CLASE 1	-
garantizado guaranteed garanti Гарантированно	A - LA - HA	CLASE 5	R11	CLASE 3	CLASE C



**Gres extruido de pasta blanca de baja absorción de agua, según UNE-EN 14411, grupo Alb, esmaltado.**  
White body extruded stoneware with low water absorption, according to EN 14411, group Alb, glazed.

COLECCIÓN	ABSORCIÓN DE AGUA WATER ABSORPTION ABSORPTION D'EAU ВОДОПОГЛОЩЕНИЕ	RESISTENCIA A LA FLEXIÓN MODULUS OF RUPTUR RESISTANCE À LA FLEXION СОПРОТИВЛЕНИЕ НА ИЗГИБ	RESISTENCIA A LA ABRASIÓN (PEI) DEEP ABRASION RESISTANCE RÉSISTANCE À L'ABRASION СТОЙКОСТЬ К ИСТИРАНИЮ ПОВЕРХНОСТИ	RESISTENCIA AL CHOQUE TÉRMICO THERMAL SHOCK RESISTANCE RESIST. AUX VARIATIONS THERMIQUES СТОЙКОСТЬ К ТЕПЛОВЫМ ПЕРЕПАДАМ	RESISTENCIA AL CUARTEO CRACKING RESISTANCE RÉSISTANCE AU TRESSAILLAGE УСТОЙЧИВОСТЬ К РАСТРЕКИВАНИЮ
					
	ISO 10545-3	ISO 10545-4	ISO 10545-7	ISO 10545-9	ISO 10545-11
ÓPERA	< 1,5%	>30 N/mm <sup>2</sup> >1800 N	4	garantizado guaranteed garanti Гарантированно	garantizado guaranteed garanti Гарантированно
MEDITERRÁNEO	< 1,5%	>30 N/mm <sup>2</sup> >1800 N	2 grafito 4 arena	garantizado guaranteed garanti Гарантированно	garantizado guaranteed garanti Гарантированно
MILÁN	< 1,5%	>30 N/mm <sup>2</sup> >1800 N	4 arena / gris 3 marengo	garantizado guaranteed garanti Гарантированно	garantizado guaranteed garanti Гарантированно
ALBAROC	< 1,5%	>30 N/mm <sup>2</sup> >1800 N	4 hulla 5 boal/galena	garantizado guaranteed garanti Гарантированно	garantizado guaranteed garanti Гарантированно
LITOS	< 1,5%	>30 N/mm <sup>2</sup> >1800 N	4	garantizado guaranteed garanti Гарантированно	garantizado guaranteed garanti Гарантированно
ROCA	< 1,5%	>30 N/mm <sup>2</sup> >1800 N	5	garantizado guaranteed garanti Гарантированно	garantizado guaranteed garanti Гарантированно
MANHATTAN	< 1,5%	>30 N/mm <sup>2</sup> >1300 N	4	garantizado guaranteed garanti Гарантированно	garantizado guaranteed garanti Гарантированно
PETRA	< 1,5%	>30 N/mm <sup>2</sup> >1800 N	4	garantizado guaranteed garanti Гарантированно	garantizado guaranteed garanti Гарантированно

RESISTENCIA A LA HELADA FROST RESISTANCE RESISTANCE AU GEL МОРОЗОСТОЙКОСТЬ	RESISTENCIA A LOS AGENTES QUÍMICOS CHEMICAL RESISTANCE RESISTANCE AUX PRODUITS CHIMIQUES СТОЙКОСТЬ К ВОЗДЕЙСТВИЮ ХИМИКАТОВ	RESISTENCIA A LAS MANCHAS STAIN RESISTANCE RÉSISTANCE AUX TACHES УСТОЙЧИВОСТЬ К ОБРАЗОВАНИЮ ПЯТЕН	RESISTENCIA AL DESLIZAMIENTO (rampa pie calzado) ANTI-SLIP RESISTANCE (ramp) RÉSISTANCE AU GLISSEMENT (pied chaussé) СОПРОТИВЛЕНИЕ СКОЛЬЖЕНИЮ (если ходит обутым)	RESISTENCIA AL DESLIZAMIENTO (C.T.E.) ANTI-SLIP RESISTANCE RÉSISTANCE AU GLISSEMENT (C.T.E.) СОПРОТИВЛЕНИЕ СКОЛЬЖЕНИЮ (C.T.E.)	RESISTENCIA AL DESLIZAMIENTO (pie descalzo) ANTI-SLIP RESISTANCE (bare foot) RÉSISTANCE AU GLISSEMENT (pied nu) СОПРОТИВЛЕНИЕ СКОЛЬЖЕНИЮ (босые ноги)
					
ISO 10545-12	ISO 10545-13	ISO 10545-14	DIN 51130	UNE 41901 EX	DIN 51097
garantizado guaranteed garanti Гарантированно	A - LA - HA	CLASE 5	R9 normal R12 anti-slip	CLASE 1 normal CLASE 3 anti-slip	- CLASE C
garantizado guaranteed garanti Гарантированно	A - LA - HA	CLASE 5	R9 normal R11 anti-slip	CLASE 1 norma CLASE 3 anti-slip	- -
garantizado guaranteed garanti Гарантированно	A - LA - HA	CLASE 5	R9 normal R12 anti-slip	CLASE 1 normal CLASE 3 anti-slip	- CLASE C
garantizado guaranteed garanti Гарантированно	A - LA - HA	CLASE 5	R10 normal R12 anti-slip	CLASE 1 normal CLASE 3 anti-slip	- CLASE C
garantizado guaranteed garanti Гарантированно	A - LA - HA	CLASE 5	R9 normal R12 anti-slip	CLASE 1 normal CLASE 3 anti-slip	- CLASE C
garantizado guaranteed garanti Гарантированно	A - LA - HA	CLASE 5	R9 normal R12 anti-slip	CLASE 1 normal CLASE 3 anti-slip	- CLASE C
garantizado guaranteed garanti Гарантированно	A - LA - HA	CLASE 5	R11	CLASE 2	-
garantizado guaranteed garanti Гарантированно	A - LA - HA	CLASE 5	R12	CLASE 3	CLASE C













**Gres extruido de pasta blanca de baja absorción de agua, según UNE-EN 14411, grupo Alb, esmaltado.**  
White body extruded stoneware with low water absorption, according to EN 14411, group Alb, glazed.

COLECCIÓN	ABSORCIÓN DE AGUA WATER ABSORPTION ABSORPTION D'EAU ВОДОПОГЛОЩЕНИЕ	RESISTENCIA A LA FLEXIÓN MODULUS OF RUPTUR RÉSISTANCE À LA FLEXION СОПРОТИВЛЕНИЕ НА ИЗГИБ	RESISTENCIA A LA ABRASIÓN (PEI) DEEP ABRASION RESISTANCE RÉSISTANCE À L'ABRASION СТОЙКОСТЬ К ИСТИРАНИЮ ПОВЕРХНОСТИ	RESISTENCIA AL CHOQUE TÉRMICO THERMAL SHOCK RESISTANCE RÉSIST. AUX VARIATIONS THERMIQUES СТОЙКОСТЬ К ТЕПЛОВЫМ ПЕРЕПАДАМ	RESISTENCIA AL CUARTEO CRACKING RESISTANCE RÉSISTANCE AU TRESSAILLAGE УСТОЙЧИВОСТЬ К РАСТРЕКИВАНИЮ
VEGA	< 1,5%	>30 N/mm <sup>2</sup> >1800 N	2 rojo/rojo anti-slip 3 ocre/visón 4 ocre anti-slip/gris 5 gris anti-slip/visón anti-slip	garantizado guaranteed garanti Гарантированно	garantizado guaranteed garanti Гарантированно
LUCCA	< 1,5%	>30 N/mm <sup>2</sup> >1800 N	4	garantizado guaranteed garanti Гарантированно	garantizado guaranteed garanti Гарантированно
ALHAMAR	< 1,5%	>30 N/mm <sup>2</sup> >1800 N	3 rojo 4 blanco/paja/salmón	garantizado guaranteed garanti Гарантированно	garantizado guaranteed garanti Гарантированно
METÁLICA	< 1,5%	>30 N/mm <sup>2</sup> >1800 N	3	garantizado guaranteed garanti Гарантированно	garantizado guaranteed garanti Гарантированно

RESISTENCIA A LA HELADA FROST RESISTANCE RÉSISTANCE AU GEL МОРОЗОСТОЙКОСТЬ	RESISTENCIA A LOS AGENTES QUÍMICOS CHEMICAL RESISTANCE RÉSISTANCE AUX PRODUITS CHIMIQUES СТОЙКОСТЬ К ВОЗДЕЙСТВИЮ ХИМИКАТОВ	RESISTENCIA A LAS MANCHAS STAIN RESISTANCE RÉSISTANCE AUX TACHES УСТОЙЧИВОСТЬ К ОБРАЗОВАНИЮ ПЯТЕН	RESISTENCIA AL DESLIZAMIENTO (rampa pie calzado) ANTI-SLIP RESISTANCE (ramp) RÉSISTANCE AU GLISSEMENT (pied chaussé) СОПРОТИВЛЕНИЕ СКОЛЬЖЕНИЮ (если ходит обувью)	RESISTENCIA AL DESLIZAMIENTO (C.T.E.) ANTI-SLIP RESISTANCE RÉSISTANCE AU GLISSEMENT (C.T.E.) СОПРОТИВЛЕНИЕ СКОЛЬЖЕНИЮ (C.T.E.)	RESISTENCIA AL DESLIZAMIENTO (pie descalzo) ANTI-SLIP RESISTANCE (bare foot) RÉSISTANCE AU GLISSEMENT (pied nu) СОПРОТИВЛЕНИЕ СКОЛЬЖЕНИЮ (босые ноги)
ISO 10545-12	ISO 10545-13	ISO 10545-14	DIN 51130	UNE 41901 EX	DIN 51097
garantizado guaranteed garanti Гарантированно	A - LA - HA	CLASE 5	R9 normal R10 anti-slip	CLASE 1 normal CLASE 2 anti-slip	- -
garantizado guaranteed garanti Гарантированно	A - LA - HA	CLASE 5	R9 normal R11 anti-slip	CLASE 1 normal CLASE 3 anti-slip	- CLASE C
garantizado guaranteed garanti Гарантированно	A - LA - HA	CLASE 5	R9 normal R12 anti-slip	CLASE 1 normal CLASE 3 anti-slip	- -
garantizado guaranteed garanti Гарантированно	A - LB - HB	CLASE 5	R9	CLASE 1	-



**Gres Porcelánico de pasta blanca, según UNE-EN 14411; Grupo B1a, esmaltado.**  
Dust pressed White body porcelain tile, according to EN 14411, group B1a, glazed.  
Grès cérame à pâte blanche, selon la norme EN 14411, Groupe B1a, émaillé.  
Керамогранит из белой глины, в соответствии с EN 14411; группа B1a, глазурованный.

NORMA · TEST	DESCRIPCIÓN · DESCRIPTION	REQUISITOS · STANDARDS
ISO 10545-2	 Dimensiones / Sizes Longitud y anchura / Length and width Espesor / Thickness Rectitud de los lados / Straightness of sides Ortogonalidad / Rectangularity Planaridad / Surface Flatness	± 0,6% ± 2 mm ± 5,0% ± 0,5 mm ± 0,5% ± 1,5 mm ± 0,5% ± 2 mm ± 0,5% ± 2 mm
ISO 10545-3	 Absorción de agua / Water absorption	< 0,5 %
ISO 10545-4	 Fuerza de rotura / Breaking strength	≥ 1300 N
ISO 10545-4	 Resistencia a la flexión / Modulus of rupture	≥ 35 N/mm <sup>2</sup>
ISO 10545-7	 Resistencia a la abrasión superficial / Resistance to surface abrasion	1-5
ISO 10545-9	 Resistencia al choque térmico / Resistance to thermal shock	exigida / required
ISO 10545-11	 Resistencia al cuarteo / Crazing resistance	exigida / required
ISO 10545-12	 Resistencia a la helada / Frost resistance	exigida / required
ISO 10545-13	 Resistencia a los agentes químicos / Chemical resistance	mínimo B minimum B
ISO 10545-14	 Resistencia a las manchas / Stain resistance	mínimo clase 3 / minimum class3
UNE 41901 EX	 Resistencia al deslizamiento (péndulo). Exigida C.T.E. / Slip Resistance (pendulum) C.T.E. required	-
DIN 51130	 Resistencia al deslizamiento (rampa pie calzado) Anti-slip resistance (ramp)	-
DIN 51097	 Resistencia al deslizamiento (pie descalzo) Anti-slip resistance (barefoot)	-











NUBIA bases 60x120 - 33x66,5	IMPERIAL bases 120x120 - 60x120 - 14,5x120 - 60x60 - 33x66,5	OROBICO bases 60x120 - 14,5x120	VENATTO bases 120x120 - 60x120 - 14,5x120 - 33x66,5	MARBLES bases 60x120 - 14,5x120	MARKINA bases 100x100 - 60x120 - 14,5x120
garantizado / guaranteed	garantizado / guaranteed	garantizado / guaranteed	garantizado / guaranteed	garantizado / guaranteed	garantizado / guaranteed
< 0,5 %	< 0,5 %	< 0,5 %	< 0,5 %	< 0,5 %	< 0,5 %
> 1300 N	> 1300 N	> 1300 N	> 1300 N	> 1300 N	> 1300 N
> 35 N/mm <sup>2</sup>	> 35 N/mm <sup>2</sup>	> 35 N/mm <sup>2</sup>	> 35 N/mm <sup>2</sup>	> 35 N/mm <sup>2</sup>	> 35 N/mm <sup>2</sup>
4	4	4	4	5	5 bianco 1 nero
garantizado / guaranteed	garantizado / guaranteed	garantizado / guaranteed	garantizado / guaranteed	garantizado / guaranteed	garantizado / guaranteed
garantizado / guaranteed	garantizado / guaranteed	garantizado / guaranteed	garantizado / guaranteed	garantizado / guaranteed	garantizado / guaranteed
garantizado / guaranteed	garantizado / guaranteed	garantizado / guaranteed	garantizado / guaranteed	garantizado / guaranteed	garantizado / guaranteed
A-LA-HA	A-LA-HA	A-LA-HA	A-LA-HA	A-LA-HA	A-LA-HA
clase 5 / class 5	clase 5 / class 5	clase 5 / class 5	clase 5 / class 5	clase 5 / class 5	clase 5 / class 5
Normal - clase 1 / class 1 Anti-slip - clase 3 / class 3	Normal - clase 1 / class 1 Anti-slip - clase 3 / class 3	clase 1 / class 1	Normal - clase 1 / class 1 Anti-slip - clase 3 / class 3	clase 1 / class 1	Normal - clase 1 / class 1 Anti-slip - clase 3 / class 3
Normal - R9 Anti-slip - R11	Normal - R9 Anti-slip - R11		Normal - R9 Anti-slip - R11		Normal - R9 Anti-slip - R11
Anti-slip clase c / class c	Anti-slip clase c / class c		Anti-slip clase c / class c		

**Gres Porcelánico de pasta blanca, según UNE-EN 14411; Grupo B1a, esmaltado.**

White body porcelain tile, according to EN 14411, group B1a, glazed.

Grès cérame à pâte blanche, selon la norme EN 14411, Groupe B1a, émaillé.

Керамогранит из белой глины, в соответствии с EN 14411; группа B1a, глазурованный.

NORMA · TEST	DESCRIPCIÓN · DESCRIPTION	REQUISITOS · STANDARDS
ISO 10545-2	 Dimensiones / Sizes Longitud y anchura / Length and width Espesor / Thickness Rectitud de los lados / Straightness of sides Ortogonalidad / Rectangularity Planaridad / Surface Flatness	± 0,6% ± 2 mm ± 5,0% ± 0,5 mm ± 0,5% ± 1,5 mm ± 0,5% ± 2 mm ± 0,5% ± 2 mm
ISO 10545-3	 Absorción de agua / Water absorption	< 0,5 %
ISO 10545-4	 Fuerza de rotura / Breaking strength	≥ 1300 N
ISO 10545-4	 Resistencia a la flexión / Modulus of rupture	≥ 35 N/mm <sup>2</sup>
ISO 10545-7	 Resistencia a la abrasión superficial / Resistance to surface abrasion	1-5
ISO 10545-9	 Resistencia al choque térmico / Resistance to thermal shock	exigida / required
ISO 10545-11	 Resistencia al cuarteo / Crazing resistance	exigida / required
ISO 10545-12	 Resistencia a la helada / Frost resistance	exigida / required
ISO 10545-13	 Resistencia a los agentes químicos / Chemical resistance	mínimo B minimum B
ISO 10545-14	 Resistencia a las manchas / Stain resistance	mínimo clase 3 / minimum class3
UNE 41901 EX	 Resistencia al deslizamiento (péndulo). Exigida C.T.E. / Slip Resistance (pendulum) C.T.E. required	-
DIN 51130	 Resistencia al deslizamiento (rampa pie calzado) Anti-slip resistance (ramp)	-
DIN 51097	 Resistencia al deslizamiento (pie descalzo) Anti-slip resistance (barefoot)	-

YOHO bases 25x150 - 14,5x120	KIOTO bases 20x120 - 14,5x120	ÓPERA bases 120x120 - 60x120 - 14,5x120	MILÁN bases 75x75 - 14,5x120	ALBAROC bases 100x100 - 14,5x120	LITOS bases 100x100 - 60x120 - 14,5x120
garantizado / guaranteed	garantizado / guaranteed	garantizado / guaranteed	garantizado / guaranteed	garantizado / guaranteed	garantizado / guaranteed
< 0,5 %	< 0,5 %	< 0,5 %	< 0,5 %	< 0,5 %	< 0,5 %
> 2800 N	> 2800 N	> 2800 N	> 2800 N	> 2800 N	> 2800 N
> 45 N/mm <sup>2</sup>	> 45 N/mm <sup>2</sup>	> 45 N/mm <sup>2</sup>	> 45 N/mm <sup>2</sup>	> 45 N/mm <sup>2</sup>	> 45 N/mm <sup>2</sup>
5	4	4	4 arena / gris 5 marengo	4 hulla 5 boal / galena	4
garantizado / guaranteed	garantizado / guaranteed	garantizado / guaranteed	garantizado / guaranteed	garantizado / guaranteed	garantizado / guaranteed
garantizado / guaranteed	garantizado / guaranteed	garantizado / guaranteed	garantizado / guaranteed	garantizado / guaranteed	garantizado / guaranteed
garantizado / guaranteed	garantizado / guaranteed	garantizado / guaranteed	garantizado / guaranteed	garantizado / guaranteed	garantizado / guaranteed
A-LA-HA	A-LA-HA	A-LA-HA	A-LA-HA	A-LA-HA	A-LA-HA
clase 5 / class 5	clase 5 / class 5	clase 5 / class 5	clase 5 / class 5	clase 5 / class 5	clase 5 / class 5
Normal - clase 1 / class 1 Anti-slip - clase 3 / class 3	clase 1 / class 1	Normal - clase 1 / class 1 Anti-slip - clase 3 / class 3	Normal - clase 1 / class 1 Anti-slip - clase 3 / class 3	Normal - clase 1 / class 1 Anti-slip - clase 3 / class 3	Normal - clase 1 / class 1 Anti-slip - clase 3 / class 3
Normal - R9 Anti-slip - R11	-	Normal - R9 Anti-slip - R12	Normal - R9 Anti-slip - R12	Normal - R10 Anti-slip - R12	Normal - R9 Anti-slip - R12
Anti-slip clase c / class c	-	Anti-slip clase c / class c	Anti-slip clase c / class c	-	Anti-slip clase c / class c



## MARBLE

NUBIA	MEDICIONES · MEASUREMENTS · MESURE · ШТУКИ/ м	CAJAS · BOXES · BOITES · КОРОБКИ	PALETS · PALLETS · PALLETES · ПАЛЛЕТЫ	MEDIDAS DE FABRICACIÓN · MANUFACTURING MEASURES
Base 60x120 cm - 10,2 mm	1,39 pcs / m <sup>2</sup>	2 pcs. / 36,5 Kg	27 boxes / 987 Kg	600x1200 mm
Base 33x66,5 cm - 10 mm	4,5 pcs. / m <sup>2</sup>	5 pcs. / 25,38 Kg	40 boxes / 1.015 Kg	-
Peldaño recto 33x120x4 cm - 12 mm	0,83 pcs / ml	2 pcs. / 25,90 Kg	11 boxes / 285 Kg	-
Media caña 33x4 cm - r-3	3 pcs / ml	52 pcs. / 13 Kg	64 boxes / 832 Kg	-
Uña 4x4 cm	-	4 pcs. / 0,4 Kg	72 boxes / 30 Kg	-
Arista 33x3 cm - r-3	3 pcs / ml	70 pcs. / 13 Kg	64 boxes / 832 Kg	-
Uña arista 3x3 cm	-	4 pcs. / 0,4 Kg	72 boxes / 30 Kg	-

IMPERIAL	MEDICIONES · MEASUREMENTS · MESURE · ШТУКИ/ м	CAJAS · BOXES · BOITES · КОРОБКИ	PALETS · PALLETS · PALLETES · ПАЛЛЕТЫ	MEDIDAS DE FABRICACIÓN · MANUFACTURING MEASURES
Base 120x120 cm - 10 mm	0,69 pcs / m <sup>2</sup>	1 pcs. / 34,35 Kg	38 boxes / 1.306 Kg	1198x1198 mm
Base 60x120 cm - 10 mm	1,39 pcs / m <sup>2</sup>	2 pcs. / 38,50 Kg	27 boxes / 1.040 Kg	598x1198 mm
Base 14,5x120 cm - 10 mm	5,75 pcs / m <sup>2</sup>	4 pcs. / 17,20 Kg	64 boxes / 1.100 Kg	145x1198 mm
Base 60x60 cm - 10,3 mm	2,77 pcs / m <sup>2</sup>	4 pcs. / 32 Kg	30 boxes / 960 Kg	-
Base 33x66,5 cm - 10 mm	4,5 pcs. / m <sup>2</sup>	5 pcs. / 25,38 Kg	40 boxes / 1.015 Kg	-
Peldaño recto 33x120x3 cm - 12 mm	0,83 pcs / ml	2 pcs. / 25,90 Kg	11 boxes / 285 Kg	-
Remate peldaño recto 3x3 cm	-	20 pcs. / 3,2 Kg	82 boxes / 263 Kg	-
Zanquín recto izda/dcha 42,3x17,5 cm	-	14 pcs. / 10,0 Kg	54 boxes / 540 Kg	-
Peldaño ML 120 33x120x4 cm - 12 mm	0,83 pcs. / ml	2 pcs. / 28 Kg	10 boxes / 280 Kg	-
Remate ML 4x33 cm	-	20 pcs.	92 boxes	-
Zanquín ML izda/dcha 39,5x17,5 cm	-	14 pcs. / 10,00 Kg	54 boxes / 540 Kg	-
Rodapié 9x60 cm - 11 mm	1,66 pcs / ml	18 pcs. / 19,80 Kg	56 boxes / 1.109 Kg	-
Borde Skimmer 45x75 cm	1,33 pcs. / ml	2 pcs. / 30 Kg	29 boxes / 870 Kg	-
Borde desbordante 28x66,5 cm	1,5 pcs. / ml	2 pcs. / 13,60 Kg	72 boxes / 980 Kg	-
Ángulo borde desbordante 31x31 cm	-	1 pcs. / 4,30 Kg	92 boxes / 396 Kg	-
Rejilla 24,5x24,5 cm	4 pcs. / ml	6 pcs. / 15,78 Kg	57 boxes / 900 Kg	-
Ángulo rejilla izda/dcha. 24,5x33 cm	-	1 pcs. / 4,50 Kg	82 boxes / 369 Kg	-
Media caña 33x4 cm - r-3	3 pcs. / ml	52 pcs. / 13 Kg	64 boxes / 832 Kg	-
Uña 4x4 cm	-	4 pcs. / 0,4 Kg	72 boxes / 30 Kg	-
Arista 33x3 cm - r-3	3 pcs. / ml	70 pcs. / 13 Kg	64 boxes / 832 Kg	-
Uña arista 3x3 cm	-	4 pcs. / 0,4 Kg	72 boxes / 30 Kg	-
Ángulo exterior arista 5x5 cm	-	-	-	-
Ángulo interior arista 5x5 cm	-	-	-	-

OROBICO	MEDICIONES · MEASUREMENTS · MESURE · ШТУКИ/ м	CAJAS · BOXES · BOITES · КОРОБКИ	PALETS · PALLETS · PALLETES · ПАЛЛЕТЫ	MEDIDAS DE FABRICACIÓN · MANUFACTURING MEASURES
Base 60x120 cm - 10,2 mm	1,39 pcs / m <sup>2</sup>	2 pcs. / 36,5 Kg	27 boxes / 987 Kg	600x1200 mm
Base 14,5x120 cm - 10,2 mm	5,75 pcs / m <sup>2</sup>	4 pcs. / 18,48 Kg	64 boxes / 1.195 Kg	-
Peldaño ML 120 33x120x4 cm - 13 mm	0,83 pcs. / ml	2 pcs. / 28 Kg	10 boxes / 280 Kg	-
Remate ML 4x33 cm	-	20 pcs.	92 boxes	-
Zanquín ML izda/dcha 39,5x17,5 cm	-	14 pcs. / 10,00 Kg	54 boxes / 540 Kg	-
Rodapié 9x60 cm - 11 mm	1,66 pcs / ml	18 pcs. / 19,80 Kg	56 boxes / 1.109 Kg	-

VENATTO	MEDICIONES · MEASUREMENTS · MESURE · ШТУКИ/ м	CAJAS · BOXES · BOITES · КОРОБКИ	PALETS · PALLETS · PALLETES · ПАЛЛЕТЫ	MEDIDAS DE FABRICACIÓN · MANUFACTURING MEASURES
Base 120x120 cm - 10 mm	0,69 pcs / m <sup>2</sup>	1 pcs. / 34,35 Kg	38 boxes / 1.306 Kg	1198x1198 mm
Base 60x120 cm - 10 mm	1,39 pcs / m <sup>2</sup>	2 pcs. / 38,50 Kg	27 boxes / 1.040 Kg	598x1198 mm
Base 14,5x120 cm - 10 mm	5,75 pcs / m <sup>2</sup>	4 pcs. / 17,20 Kg	64 boxes / 1.100 Kg	145x1198 mm
Base 33x66,5 cm - 10 mm	4,5 pcs. / m <sup>2</sup>	5 pcs. / 25,38 Kg	40 boxes / 1.015 Kg	-
Peldaño ML 120 33x120x4 cm - 13 mm	0,83 pcs. / m <sup>2</sup>	2 pcs. / 28 Kg	10 boxes / 280 Kg	-
Remate ML 4x33 cm	-	20 pcs.	92 boxes	-
Zanquín ML izda/dcha 39,5x17,5 cm	-	14 pcs. / 10,00 Kg	54 boxes / 540 Kg	-
Rodapié 9x60 cm - 11 mm	1,66 pcs / ml	18 pcs. / 19,80 Kg	56 boxes / 1.109 Kg	-
Borde Skimmer 45x75 cm	1,33 pcs. / ml	2 pcs. / 30 Kg	29 boxes / 870 Kg	-
Borde desbordante 28x66,5 cm	1,5 pcs. / ml	2 pcs. / 13,60 Kg	72 boxes / 980 Kg	-
Ángulo borde desbordante 31x31 cm	-	1 pcs. / 4,30 Kg	92 boxes / 396 Kg	-
Rejilla 24,5x24,5 cm	4 pcs. / ml	6 pcs. / 15,78 Kg	57 boxes / 900 Kg	-
Ángulo rejilla izda/dcha 24,5x33 cm	-	1 pcs. / 4,50 Kg	82 boxes / 369 Kg	-
Media caña 33x4 cm - r-3	3 pcs. / ml	52 pcs. / 13 Kg	64 boxes / 832 Kg	-
Uña 4x4 cm	-	4 pcs. / 0,4 Kg	72 boxes / 30 Kg	-
Arista 33x3 cm - r-3	3 pcs. / ml	70 pcs. / 13 Kg	64 boxes / 832 Kg	-
Uña arista 3x3 cm	-	4 pcs. / 0,4 Kg	72 boxes / 30 Kg	-
Ángulo exterior arista 5x5 cm	-	-	-	-
Ángulo interior arista 5x5 cm	-	-	-	-

## MARBLE

MARKINA	MEDICIONES · MEASUREMENTS · MESURE · ШТУКИ/ м	CAJAS · BOXES · BOITES · КОРОБКИ	PALETS · PALLETS · PALLETES · ПАЛЛЕТЫ	MEDIDAS DE FABRICACIÓN · MANUFACTURING MEASURES
Base 62x120 cm - 11 mm	1,49 pcs / m <sup>2</sup>	2 pcs. / 36,06 Kg	32 boxes / 1.169 Kg	-
Base 14,5x120 cm - 11 mm	5,75 pcs / m <sup>2</sup>	4 pcs. / 18,48 Kg	64 boxes / 1.195 Kg	-
Peldaño recto 33x120x3 cm - 12 mm	0,83 pcs / ml	2 pcs. / 25,90 Kg	11 boxes / 285 Kg	-
Remate peldaño recto 3x33 cm	-	20 pcs. / 3,2 Kg	82 boxes / 263 Kg	-
Zanquin recto izda/dcha 18x40 cm	-	6 pcs. / 15 Kg	57 boxes / 855 Kg	-
Rodapié 9x40 cm - 15 mm	2,5 pcs / ml	12 pcs. / 15 Kg	66 boxes / 990 Kg	-

MARBLES	MEDICIONES · MEASUREMENTS · MESURE · ШТУКИ/ м	CAJAS · BOXES · BOITES · КОРОБКИ	PALETS · PALLETS · PALLETES · ПАЛЛЕТЫ	MEDIDAS DE FABRICACIÓN · MANUFACTURING MEASURES
Base 60x120 cm - 10,2 mm	1,39 pcs / m <sup>2</sup>	2 pcs. / 36,5 Kg	27 boxes / 987 Kg	-
Base 14,5x120 cm - 10,2 mm	5,75 pcs / m <sup>2</sup>	4 pcs. / 18,48 Kg	64 boxes / 1.195 Kg	-
Base 33x66,5 cm - 10 mm	4,5 pcs. / m <sup>2</sup>	5 pcs. / 25,38 Kg	40 boxes / 1.015 Kg	-
Peldaño recto 33x120x3 cm - 12 mm	0,83 pcs / ml	2 pcs. / 25,90 Kg	11 boxes / 285 Kg	-
Peldaño fiorentino 33x120x3 cm - 12 mm	0,83 pcs / ml	2 pcs. / 25,90 Kg	11 boxes / 285 Kg	-
Peldaño recto 33x60x3 cm - 12 mm	1,66 pcs / ml	2 pcs. / 11,70 Kg	20 boxes / 234 Kg	-
Remate peldaño recto 3x33 cm	-	20 pcs. / 3,2 Kg	82 boxes / 263 Kg	-
Remate peldaño fiorentino 3x33 cm	-	20 pcs. / 3,2 Kg	82 boxes / 263 Kg	-
Zanquin recto izda/dcha 18x40 cm	-	6 pcs. / 15 Kg	57 boxes / 855 Kg	-
Zanquin fiorentino izda/dcha 18x40 cm	-	6 pcs. / 15 Kg	57 boxes / 855 Kg	-
Media caña 33x4,2 cm - r-3	3 pcs / ml	52 pcs. / 13 Kg	64 boxes / 832 Kg	-
Uña 4,2x4,2 cm	-	4 pcs. / 0,4 Kg	72 boxes / 30 Kg	-
Arista 33x3,3 cm - r-3	3 pcs / ml	70 pcs. / 13 Kg	64 boxes / 832 Kg	-
Uña arista 3,3x3,3 cm	-	4 pcs. / 0,4 Kg	72 boxes / 30 Kg	-
Rodapié 9x40 cm - 15 mm	2,5 pcs / ml	12 pcs. / 15 Kg	66 boxes / 990 Kg	-

## WOOD

YOHO	MEDICIONES · MEASUREMENTS · MESURE · ШТУКИ/ м	CAJAS · BOXES · BOITES · КОРОБКИ	PALETS · PALLETS · PALLETES · ПАЛЛЕТЫ	MEDIDAS DE FABRICACIÓN · MANUFACTURING MEASURES
Base 24,5x150 cm - 11 mm	2,72 pcs / m <sup>2</sup>	3 pcs. / 29,25 Kg	42 boxes / 1.230 Kg	245x1500 mm
Base 14,5x120 cm - 10,2 mm	5,75 pcs / m <sup>2</sup>	4 pcs. / 18,48 Kg	64 boxes / 1.195 Kg	-
Base 16,25x66,5 cm - 10 mm	9 pcs. / m <sup>2</sup>	10 pcs. / 25,30 Kg	40 boxes / 1.012 Kg	-
Peldaño recto 33x120x3 cm - 12 mm	0,83 pcs / ml	2 pcs. / 25,90 Kg	11 boxes / 285 Kg	-
Remate peldaño recto 3x33 cm	-	20 pcs. / 3,2 Kg	82 boxes / 263 Kg	-
Zanquin recto izda/dcha 42,3x17,5 cm	-	14 pcs. / 10,0 Kg	54 boxes / 540 Kg	-
Rodapié 9x60 cm - 11 mm	1,66 pcs / ml	18 pcs. / 19,80 Kg	56 boxes / 1.109 Kg	-
Borde Skimmer 45x75 cm	1,33 pcs. / ml	2 pcs. / 30 Kg	29 boxes / 870 Kg	-

KIOTO	MEDICIONES · MEASUREMENTS · MESURE · ШТУКИ/ м	CAJAS · BOXES · BOITES · КОРОБКИ	PALETS · PALLETS · PALLETES · ПАЛЛЕТЫ	MEDIDAS DE FABRICACIÓN · MANUFACTURING MEASURES
Base 20x120 cm - 10,2 mm	4,17 pcs / m <sup>2</sup>	5 pcs. / 30,65 Kg	36 boxes / 1.115 Kg	197x1200 mm
Base 14,5x120 cm - 10,2 mm	5,75 pcs / m <sup>2</sup>	4 pcs. / 18,48 Kg	64 boxes / 1.195 Kg	-
Peldaño fiorentino 33x120x3 cm - 12 mm	0,83 pcs / ml	2 pcs. / 25,90 Kg	11 boxes / 285 Kg	-
Peldaño recto 33x120x3 cm - 12 mm	0,83 pcs / ml	2 pcs. / 25,90 Kg	11 boxes / 285 Kg	-
Remate peldaño fiorentino 3x33 cm	-	20 pcs. / 3,2 Kg	82 boxes / 263 Kg	-
Remate peldaño recto 3x33 cm	-	20 pcs. / 3,2 Kg	82 boxes / 263 Kg	-
Zanquin fiorentino izda/dcha 39,5x17,5 cm	-	14 pcs. / 10,0 Kg	54 boxes / 540 Kg	-
Zanquin recto izda/dcha 42,3x17,5 cm	-	14 pcs. / 10,0 Kg	54 boxes / 540 Kg	-
Rodapié 9x60 cm - 11 mm	1,66 pcs / ml	18 pcs. / 19,80 Kg	56 boxes / 1.109 Kg	-

NATURA	MEDICIONES · MEASUREMENTS · MESURE · ШТУКИ/ м	CAJAS · BOXES · BOITES · КОРОБКИ	PALETS · PALLETS · PALLETES · ПАЛЛЕТЫ	MEDIDAS DE FABRICACIÓN · MANUFACTURING MEASURES
Base 16,25x66,5 cm - 10 mm	9 pcs. / m <sup>2</sup>	10 pcs. / 25,30 Kg	40 boxes / 1.012 Kg	-
Rodapié 9x33 cm - 11 mm	3 pcs. / ml	24 pcs. / 13,92 Kg	68 boxes / 947 Kg	-
Peldaño Fiorentino 33x33x3 cm - 12 mm	3 pcs. / ml	4 pcs. / 12,49 Kg	56 boxes / 700 Kg	-
Cartabón Fiorentino 33x33x3 cm - 14 mm	-	1 pcs. / 4,00 Kg	92 boxes / 368 Kg	-
Zanquin Fiorent. izda/dcha 39,5x17,5 cm	-	14 pcs. / 10,00 Kg	54 boxes / 540 Kg	-
Borde piscina 28x66,5 cm	1,5 pcs. / ml	1 pcs. / 10,75 Kg	72 boxes / 774 Kg	-
Ángulo Interior 33x33 cm	-	1 pcs. / 4,80 Kg	92 boxes / 441 Kg	-
Ángulo exterior 28x28 cm	-	1 pcs. / 4,00 Kg	92 boxes / 368 Kg	-



## URBAN

ÓPERA	MEDICIONES · MEASUREMENTS · MESURE · ШТУКИ/ m	CAJAS · BOXES · BOITES · КОРБОККИ	PALETS · PALLETS · PALLETES · ПАЛЛЕТЫ	MEDIDAS DE FABRICACIÓN · MANUFACTURING MEASURES
Base 120x120 cm - 10 mm	0,69 pcs / m <sup>2</sup>	1 pcs. / 34,35 Kg	38 boxes / 1.306 Kg	1198x1198 mm
Base 60x120 cm - 10 mm	1,39 pcs / m <sup>2</sup>	2 pcs. / 38,50 Kg	27 boxes / 1.040 Kg	598x1198 mm
Base 14,5x120 cm - 10 mm	5,75 pcs / m <sup>2</sup>	4 pcs. / 17,20 Kg	64 boxes / 1.100 Kg	145x1198 mm
Base 33x66,5 cm - 10 mm	4,5 pcs. / m <sup>2</sup>	5 pcs. / 25,38 Kg	40 boxes / 1.015 Kg	-
Peldaño recto 33x120x3 cm - 12 mm	0,83 pcs / ml	2 pcs. / 25,90 Kg	11 boxes / 285 Kg	-
Remate peldaño recto 3x33 cm	-	20 pcs. / 3,2 Kg	82 boxes / 263 Kg	-
Zanquin recto izda/dcha 42,3x17,5 cm	-	14 pcs. / 10,0 Kg	54 boxes / 540 Kg	-
Rodapié 9x60 cm - 11 mm	1,66 pcs / ml	18 pcs. / 19,80 Kg	4256 boxes / 1.109 Kg	-
Borde Skimmer 45x75 cm	1,33 pcs. / ml	2 pcs. / 30 Kg	29 boxes / 870 Kg	-
Borde desbordante 28x66,5 cm	1,5 pcs. / ml	2 pcs. / 13,60 Kg	72 boxes / 980 Kg	-
Ángulo borde desbordante 31x31 cm	-	1 pcs. / 4,30 Kg	92 boxes / 396 Kg	-
Rejilla 24,5x24,5 cm	4 pcs. / ml	6 pcs. / 15,78 Kg	57 boxes / 900 Kg	-
Ángulo rejilla izda/dcha 24,5x33 cm	-	1 pcs. / 4,50 Kg	82 boxes / 369 Kg	-
Media caña 33x4,2 cm - r-3	3 pcs. / ml	52 pcs. / 13 Kg	64 boxes / 832 Kg	-
Uña 4,2x4,2 cm	-	4 pcs. / 0,4 Kg	72 boxes / 30 Kg	-
Arista 33x3,3 cm - r-3	3 pcs. / ml	70 pcs. / 13 Kg	64 boxes / 832 Kg	-
Uña arista 3,3x3,3 cm	-	4 pcs. / 0,4 Kg	72 boxes / 30 Kg	-

MEDITERRÁNEO	MEDICIONES · MEASUREMENTS · MESURE · ШТУКИ/ m	CAJAS · BOXES · BOITES · КОРБОККИ	PALETS · PALLETS · PALLETES · ПАЛЛЕТЫ	MEDIDAS DE FABRICACIÓN · MANUFACTURING MEASURES
Base 33x33 cm - 10 mm	9 pcs. / m <sup>2</sup>	9 pcs. / 22,18 Kg	52 boxes / 1.153 Kg	-
Base 33x66,5 cm - 10 mm	4,5 pcs. / m <sup>2</sup>	5 pcs. / 25,38 Kg	40 boxes / 1.015 Kg	-
Rodapié 9x33 cm - 7,5 mm	3 pcs. / ml	24 pcs. / 13,92 Kg	68 boxes / 947 Kg	-
Vierteaguas 12x33x3 cm	3 pcs. / ml	16 pcs. / 18,05 Kg	52 boxes / 938 Kg	-
Peldaño Fiorentino 33x33x3 cm - 12 mm	3 pcs. / ml	4 pcs. / 12,49 Kg	56 boxes / 700 Kg	-
Cartabón Fiorentino 33x33x3 cm - 14 mm	-	1 pcs. / 4,00 Kg	92 boxes / 368 Kg	-
Zanquin Fior. izda/dcha 39,5x17,5 cm	-	14 pcs. / 10,00 Kg	54 boxes / 540 Kg	-
Peldaño Recto 33x33x3 cm - 12 mm	3 pcs. / ml	4 pcs. / 12,04 Kg	56 boxes / 674 Kg	-
Zanquin Recto izda./dcha 42,3x17,5	-	14 pcs. / 10,00 Kg	54 boxes / 540 Kg	-
Pasamanos 12,5x66,5x4 cm	1,5 pcs. / ml	5 pcs. / 18,80 Kg	26 boxes / 489 Kg	-
Pasamanos 15,5x66,5x4 cm	1,5 pcs. / ml	5 pcs. / 21,45 Kg	20 boxes / 430 Kg	-

## STONE

MILÁN	MEDICIONES · MEASUREMENTS · MESURE · ШТУКИ/ m	CAJAS · BOXES · BOITES · КОРБОККИ	PALETS · PALLETS · PALLETES · ПАЛЛЕТЫ	MEDIDAS DE FABRICACIÓN · MANUFACTURING MEASURES
Base 75x75 cm - 11 mm	1,78 pcs / m <sup>2</sup>	2 pcs. / 29,50 Kg	40 boxes / 1.170 Kg	-
Base 14,5x120 cm - 10,2 mm	5,75 pcs / m <sup>2</sup>	4 pcs. / 18,48 Kg	64 boxes / 1.195 Kg	-
Base 33x33 cm - 10 mm	9 pcs. / m <sup>2</sup>	9 pcs. / 22,18 Kg	52 boxes / 1.153 Kg	-
Peldaño recto 33x120x3 cm - 12 mm	0,83 pcs / ml	2 pcs. / 25,90 Kg	11 boxes / 285 Kg	-
Remate peldaño recto 3x33 cm	-	20 pcs. / 3,20 Kg	82 boxes / 263 Kg	-
Zanquin recto izda/dcha 42,3x17,5 cm	-	14 pcs. / 10,0 Kg	54 boxes / 540 Kg	-
Rodapié 9x60 cm - 11 mm	1,66 pcs / ml	18 pcs. / 19,80 Kg	56 boxes / 1.109 Kg	-
Borde Skimmer 45x75 cm	1,33 pcs. / ml	2 pcs. / 30,00 Kg	29 boxes / 870 Kg	-

ALBAROC	MEDICIONES · MEASUREMENTS · MESURE · ШТУКИ/ m	CAJAS · BOXES · BOITES · КОРБОККИ	PALETS · PALLETS · PALLETES · ПАЛЛЕТЫ	MEDIDAS DE FABRICACIÓN · MANUFACTURING MEASURES
Base 100x100 cm - 11 mm	1 pcs / m <sup>2</sup>	1 pcs. / 25 Kg	48 boxes / 1.200 Kg	-
Base 14,5x120 cm - 10,2 mm	5,75 pcs / m <sup>2</sup>	4 pcs. / 18,48 Kg	64 boxes / 1.195 Kg	-
Base 33x66,5 cm - 10 mm	4,5 pcs. / m <sup>2</sup>	5 pcs. / 25,38 Kg	40 boxes / 1.015 Kg	-
Base 33x33 cm - 10 mm	9 pcs. / m <sup>2</sup>	9 pcs. / 22,18 Kg	52 boxes / 1.153 Kg	-
Peldaño ML 33x33x4 cm - 13 mm	3 pcs. / ml	4 pcs. / 13,40 Kg	44 boxes / 590 Kg	-
Cartabón ML 33x33x4 cm - 14 mm	-	1 pcs. / 4,00 Kg	92 boxes / 368 Kg	-
Zanquin ML izda/dcha 18x40 cm	-	6 pcs. / 15,00 Kg	57 boxes / 855 Kg	-
Peldaño recto 33x120x3 cm - 12 mm	0,83 pcs / ml	2 pcs. / 25,90 Kg	11 boxes / 285 Kg	-
Remate peldaño recto 3x33 cm	-	20 pcs. / 3,2 Kg	82 boxes / 263 Kg	-
Zanquin recto izda/dcha 18x40 cm	-	6 pcs. / 15,00 Kg	57 boxes / 855 Kg	-
Pasamanos 12,5x66,5x4 cm	1,5 pcs. / ml	5 pcs. / 18,80 Kg	26 boxes / 489 Kg	-
Pasamanos 15,5x66,5x4 cm	1,5 pcs. / ml	5 pcs. / 21,45 Kg	20 boxes / 430 Kg	-
Rodapié 9x40 cm - 15 mm	2,5 pcs. / ml	12 pcs. / 15 Kg	66 boxes / 990 Kg	-

LITOS	MEDICIONES · MESUREMENTS · MESURE · ШТУКИ/ m	CAJAS · BOXES · BOITES · КОРОБКИ	PALETS · PALLETS · PALLETES · ПАЛЛЕТЫ	MEDIDAS DE FABRICACIÓN · MANUFACTURING MEASURES
Base 100x100 cm - 11 mm	1 pcs. / m <sup>2</sup>	1 pcs. / 25 Kg	48 boxes / 1.200 Kg	-
Base 60x120 cm - 10,2 mm	1,39 pcs. / m <sup>2</sup>	2 pcs. / 36,5 Kg	27 boxes / 987 Kg	-
Base 14,5x120 cm - 10,2 mm	5,75 pcs. / m <sup>2</sup>	4 pcs. / 18,48 Kg	64 boxes / 1.195 Kg	-
Base 33x66,5 cm - 10 mm	4,5 pcs. / m <sup>2</sup>	5 pcs. / 25,38 Kg	40 boxes / 1.015 Kg	-
Peldaño recto 33x120x3 cm - 12 mm	0,83 pcs. / ml	2 pcs. / 25,90 Kg	11 boxes / 285 Kg	-
Remate peldaño recto 3x33 cm	-	20 pcs. / 3,2 Kg	82 boxes / 263 Kg	-
Zanquín recto izda/dcha 18x40 cm	-	6 pcs. / 15,00 Kg	57 boxes / 855 Kg	-
Rodapié 9x40 cm - 15 mm	2,5 pcs. / ml	12 pcs. / 15 Kg	66 boxes / 990 Kg	-
Borde desbordante 28x66,5 cm	1,5 pcs. / ml	2 pcs. / 13,60 Kg	72 boxes / 980 Kg	-
Ángulo borde desbordante 31x31 cm	-	1 pcs. / 4,30 Kg	92 boxes / 396 Kg	-
Rejilla 24,5x24,5 cm	4 pcs. / ml	6 pcs. / 15,78 Kg	57 boxes / 900 Kg	-
Ángulo rejilla izda/dcha 24,5x33 cm	-	1 pcs. / 4,50 Kg	82 boxes / 369 Kg	-
Medía caña 33x4,2 cm - r-3	3 pcs. / ml	52 pcs. / 13 Kg	64 boxes / 832 Kg	-
Uña 4,2x4,2 cm	-	4 pcs. / 0,4 Kg	72 boxes / 30 Kg	-
Arista 33x3,3 cm - r-3	3 pcs. / ml	70 pcs. / 13 Kg	64 boxes / 832 Kg	-
Uña arista 3,3x3,3 cm	-	4 pcs. / 0,4 Kg	72 boxes / 30 Kg	-

ROCA	MEDICIONES · MESUREMENTS · MESURE · ШТУКИ/ m	CAJAS · BOXES · BOITES · КОРОБКИ	PALETS · PALLETS · PALLETES · ПАЛЛЕТЫ	MEDIDAS DE FABRICACIÓN · MANUFACTURING MEASURES
Base 33x33 cm - 10 mm	9 pcs. / m <sup>2</sup>	9 pcs. / 22,18 Kg	52 boxes / 1.153 Kg	-
Base 33x66,5 cm - 10 mm	4,5 pcs. / m <sup>2</sup>	5 pcs. / 25,38 Kg	40 boxes / 1.015 Kg	-
Peldaño ML 33x33x4 cm - 13 mm	3 pcs. / ml	4 pcs. / 13,40 Kg	44 boxes / 590 Kg	-
Cartabón ML 33x33x4 cm - 14 mm	-	1 pcs. / 4,00 Kg	92 boxes / 368 Kg	-
Zanquín ML izda/dcha 39,5x17,5 cm	-	14 pcs. / 10,00 Kg	54 boxes / 540 Kg	-
Peldaño Recto 33x33x3 cm - 12 mm	3 pcs. / ml	4 pcs. / 12,04 Kg	56 boxes / 675 Kg	-
Zanquín Recto izda/dcha 42,3x17,5	-	14 pcs. / 10,00 Kg	54 boxes / 540 Kg	-
Rodapié 9x33 cm - 11 mm	3 pcs. / ml	24 pcs. / 13,92 Kg	68 boxes / 947 Kg	-
Borde desbordante 28x66,5 cm	1,5 pcs. / ml	2 pcs. / 13,60 Kg	72 boxes / 980 Kg	-
Ángulo borde desbordante 31x31 cm	-	1 pcs. / 4,30 Kg	92 boxes / 396 Kg	-
Rejilla 24,5x24,5 cm	4 pcs. / ml	6 pcs. / 15,78 Kg	57 boxes / 900 Kg	-
Ángulo rejilla izda/dcha 24,5x33 cm	-	1 pcs. / 4,50 Kg	82 boxes / 369 Kg	-
Medía caña 33x4,2 cm - r-3	3 pcs. / ml	52 pcs. / 13 Kg	64 boxes / 832 Kg	-
Uña 4,2x4,2 cm	-	4 pcs. / 0,4 Kg	72 boxes / 30 Kg	-
Arista 33x3,3 cm - r-3	3 pcs. / ml	70 pcs. / 13 Kg	64 boxes / 832 Kg	-
Uña arista 3,3x3,3 cm	-	4 pcs. / 0,4 Kg	72 boxes / 30 Kg	-

MANHATTAN	MEDICIONES · MESUREMENTS · MESURE · ШТУКИ/ m	CAJAS · BOXES · BOITES · КОРОБКИ	PALETS · PALLETS · PALLETES · ПАЛЛЕТЫ	MEDIDAS DE FABRICACIÓN · MANUFACTURING MEASURES
Base 24,5x24,5 cm - 9 mm	16 pcs. / m <sup>2</sup>	16 pcs. / 19,79 Kg	69 boxes / 1.365 Kg	-
Base 12x24,5 cm - 9 mm	32 pcs. / m <sup>2</sup>	35 pcs. / 19,25 Kg	77 boxes / 1.482 Kg	-
Listelo 5,75x24,5 cm (doble)	64 pcs. / m <sup>2</sup>	72 pcs. / 20,16 Kg	77 boxes / 1.552 Kg	-
Rodapié 9x24,5 cm - 11 mm	4 pcs. / ml	32 pcs. / 12,01 Kg	80 boxes / 960 Kg	-
Vierteaguas 15x24,5x4 cm	4 pcs. / ml	8 pcs. / 7,00 Kg	78 boxes / 546 Kg	-
Peldaño ML 24,5x33x4 cm - 13 mm	4 pcs. / ml	4 pcs. / 9,50 Kg	66 boxes / 627 Kg	-
Cartabón ML 33x33x4 cm - 14 mm	-	1 pcs. / 4,00 Kg	92 boxes / 368 Kg	-
Zanquín ML izda/dcha 39,5x17,5 cm	-	14 pcs. / 10,00 Kg	54 boxes / 540 Kg	-

PETRA	MEDICIONES · MESUREMENTS · MESURE · ШТУКИ/ m	CAJAS · BOXES · BOITES · КОРОБКИ	PALETS · PALLETS · PALLETES · ПАЛЛЕТЫ	MEDIDAS DE FABRICACIÓN · MANUFACTURING MEASURES
Base 33x33 cm - 10 mm	9 pcs. / m <sup>2</sup>	9 pcs. / 22,18 Kg	52 boxes / 1.153 Kg	-
Rodapié 9x33 cm - 11 mm	3 pcs. / ml	24 pcs. / 13,92 Kg	68 boxes / 947 Kg	-
Peldaño Fiorentino 33x33x3 cm - 12 mm	3 pcs. / ml	4 pcs. / 12,49 Kg	56 boxes / 700 Kg	-
Cartabón Fiorentino 33x33x3 cm - 14 mm	-	1 pcs. / 4,00 Kg	92 boxes / 368 Kg	-
Zanquín Fior. izda/dcha 39,5x17,5 cm	-	14 pcs. / 10,00 Kg	54 boxes / 540 Kg	-
Taco Petra Etna 8x8 cm	-	108 pcs. / 17,28 Kg	-	-
Tabica Etna Petra 15x33 cm	3 pcs. / ml	12 pcs. / 13,20 Kg	90 boxes / 1.188 Kg	-
Borde piscina 28x33 cm	3 pcs. / ml	4 pcs. / 21,52 Kg	38 boxes / 817 Kg	-
Ángulo Interior 33x33 cm	-	1 pcs. / 4,80 Kg	92 boxes / 441 Kg	-
Ángulo exterior 28x28 cm	-	1 pcs. / 4,00 Kg	92 boxes / 368 Kg	-

VEGA	MEDICIONES · MESUREMENTS · MESURE · ШТУКИ/ m	CAJAS · BOXES · BOITES · КОРОБКИ	PALETS · PALLETS · PALLETES · ПАЛЛЕТЫ	MEDIDAS DE FABRICACIÓN · MANUFACTURING MEASURES
Base 33x33 cm - 10 mm	9 pcs. / m <sup>2</sup>	9 pcs. / 22,18 Kg	52 boxes / 1.153 Kg	-
Rodapié 9x33 cm - 11 mm	3 pcs. / ml	24 pcs. / 13,92 Kg	68 boxes / 947 Kg	-
Peldaño Fiorentino 33x33x3 cm - 12 mm	3 pcs. / ml	4 pcs. / 12,49 Kg	56 boxes / 700 Kg	-
Cartabón Fiorentino 33x33x3 cm - 14 mm	-	1 pcs. / 4,00 Kg	92 boxes / 368 Kg	-
Zanquín Fior. izda/dcha 39,5x17,5 cm	-	14 pcs. / 10,00 Kg	54 boxes / 540 Kg	-
Vierteaguas 12x33x3 cm	3 pcs. / ml	16 pcs. / 18,05 Kg	52 boxes / 938Kg	-



## EARTH

LUCCA	MEDICIONES · MEASUREMENTS · MESURE · ШТУКИ/ m	CAJAS · BOXES · BOITES · КОРОБКИ	PALETS · PALLETS · PALLETES · ПАЛЛЕТЫ	MEDIDAS DE FABRICACIÓN · MANUFACTURING MEASURES
Base 33x33 cm - 10 mm	9 pcs. / m <sup>2</sup>	9 pcs. / 22,18 Kg	52 boxes / 1.153 Kg	-
Base 16,25x33 cm - 10 mm	18 pcs. / m <sup>2</sup>	18 pcs. / 21,60 Kg	56 boxes / 1.210 Kg	-
Base 16,25x16,25 cm - 10 mm	36 pcs. / m <sup>2</sup>	18 pcs. / 10,80 Kg	112 boxes / 1.210 Kg	-
Rodapié 9x33 cm - 11 mm	3 pcs. / ml	24 pcs. / 13,92 Kg	68 boxes / 947 Kg	-
Peldaño ML 33x33x4 cm - 13 mm	4 pcs. / ml	4 pcs. / 13,40 Kg	44 boxes / 590 Kg	-
Cartabón ML 33x33x4 cm - 14 mm	-	1 pcs. / 4,00 Kg	92 boxes / 368 Kg	-
Zanquin ML izda/dcha 39,5x17,5 cm	-	14 pcs. / 10,00 Kg	54 boxes / 540 Kg	-
Vierteaguas 15x33x4 cm	3 pcs. / ml	8 pcs. / 10,56 Kg	52 boxes / 550 Kg	-
Borde piscina 28x33 cm	3 pcs. / ml	4 pcs. / 21,52 Kg	38 boxes / 817 Kg	-
Ángulo Interior 33x33 cm	-	1 pcs. / 4,80 Kg	92 boxes / 441 Kg	-
Ángulo exterior 28x28 cm	-	1 pcs. / 4,00 Kg	92 boxes / 368 Kg	-

ALHAMAR	MEDICIONES · MEASUREMENTS · MESURE · ШТУКИ/ m	CAJAS · BOXES · BOITES · КОРОБКИ	PALETS · PALLETS · PALLETES · ПАЛЛЕТЫ	MEDIDAS DE FABRICACIÓN · MANUFACTURING MEASURES
Base 33x33 cm - 10 mm	9 pcs. / m <sup>2</sup>	9 pcs. / 22,18 Kg	52 boxes / 1.153Kg	-
Base 16,25x33 cm - 10 mm	18 pcs. / m <sup>2</sup>	18 pcs. / 21,60 Kg	56 boxes / 1.210 Kg	-
Base 16,25x16,25 cm - 10 mm	36 pcs. / m <sup>2</sup>	18 pcs. / 10,80 Kg	112 boxes / 1.210 Kg	-
Rodapié 9x33 cm - 11 mm	3 pcs. / ml	24 pcs. / 13,92 Kg	68 boxes / 947 Kg	-
Peldaño Fiorentino 33x33x3 cm - 12 mm	3 pcs. / ml	4 pcs. / 12,48 Kg	56 boxes / 700 Kg	-
Cartabón Fiorentino 33x33x3 cm - 14 mm	-	1 pcs. / 4,00 Kg	92 boxes / 368 Kg	-
Zanquin Fior. izda/dcha 39,5x17,5 cm	-	14 pcs. / 10,00 Kg	54 boxes / 540 Kg	-
Vierteaguas 15x33x4 cm	3 pcs. / ml	8 pcs. / 10,56 Kg	52 boxes / 550 Kg	-
Decorative / Clay 33x33 cm	9 pcs. / m <sup>2</sup>	9 pcs. / 22,18 Kg	52 boxes / 1.153 Kg	-
Tabica Clay 15x33 cm	3 pcs. / ml	12 pcs. / 13,20 Kg	82 boxes / 1.083 Kg	-

## METAL

METÁLICA	MEDICIONES · MEASUREMENTS · MESURE · ШТУКИ/ m	CAJAS · BOXES · BOITES · КОРОБКИ	PALETS · PALLETS · PALLETES · ПАЛЛЕТЫ	MEDIDAS DE FABRICACIÓN · MANUFACTURING MEASURES
Base 33x33 cm - 10 mm	9 pcs. / m <sup>2</sup>	9 pcs. / 22,18 Kg	52 boxes / 1.153 Kg	-
Rodapié 9x33 cm - 11 mm	3 pcs. / ml	24 pcs. / 13,92 Kg	68 boxes / 947 Kg	-
Peldaño Fiorentino 33x33x3 cm - 12 mm	3 pcs. / ml	4 pcs. / 12,48 Kg	56 boxes / 700 Kg	-
Cartabón Fiorentino 33x33x3 cm - 14 mm	-	1 pcs. / 4,00 Kg	92 boxes / 368 Kg	-
Zanquin Flo. izda./dcha 39,5x17,5 cm	-	14 pcs. / 10,00 Kg	54 boxes / 540 Kg	-



EXAGRES se reserva el derecho de anular, modificar total o parcialmente cualquiera de los colores, formatos, referencias y especificaciones técnicas contenidas en este catálogo. Los colores reproducidos en este catálogo son orientativos y pueden variar respecto a la pieza original. Los códigos de precios, medidas y referencias deben verificarse ya que pueden haber errores tipográficos.

EXAGRES reserves the right to partially or totally cancel or modify any of the colours, formats, references and technical specifications contained in this catalogue. The colours reproduced in this catalogue are intended as a guide and may vary in the original piece. The price codes, measures and references must be verified as there may be typographical errors.

EXAGRES se réserve le droit d'annuler, de modifier totalement ou partiellement toutes les couleurs, tous les formats, toutes les références et spécificités techniques contenues dans ce catalogue. Les couleurs reproduites dans ce catalogue sont à titre indicatif et peuvent varier par rapport à la pièce originale. Les codes de prix, les mesures et les références doivent être vérifiés, car il peut y avoir des erreurs typographiques.

Компания EXAGRES оставляет за собой право отменить или изменить, полностью или частично, любой из цветов, форматов, артикулов, а также технические характеристики, содержащиеся в этом каталоге. Все приведенные в данном каталоге цвета являются приблизительными и могут незначительно отличаться от цвета оригинального изделия. Цены, размеры и номера артикулов должны быть предварительно уточнены, поскольку в каталоге могут присутствовать типографические опечатки.



products bank

residencial

Avda. Reina de los Angeles s/n  
0540 Beni  
(Castellón) Spain  
tel. (+34) 964 623 250  
info@exagres.es  
www.exagres.es